

**INTERNATIONAL STANDARDS  
AND RECOMMENDED PRACTICES**

# **AERODROMES**

**ANNEX 14 TO THE CONVENTION  
ON INTERNATIONAL CIVIL AVIATION**



**1st Edition • Effective 1 November 1951**

**INTERNATIONAL CIVIL AVIATION ORGANIZATION**

**INTERNATIONAL STANDARDS  
AND RECOMMENDED PRACTICES**

**AERODROMES**

**ANNEX 14 TO THE CONVENTION  
ON INTERNATIONAL CIVIL AVIATION**

**This Annex is published by authority of the Council.  
For implementation please refer to the introduction  
of the Foreword on page 5.**

**1st Edition ● Effective 1 November 1951**

**INTERNATIONAL CIVIL AVIATION ORGANIZATION**

Printed in English, French and Spanish, separately  
issued under the titles of:

AERODROMES

AÉRODROMES

AERÓDROMOS

---

---

Published in Montreal, Canada, by the *International Civil Aviation Organization*. Correspondence concerning publications should be addressed to the Secretary General of ICAO, International Aviation Building, 1080 University Street, Montreal, Canada.

---

---

## TABLE OF CONTENTS

	<i>Page</i>
FOREWORD .....	5
Introduction .....	5
Definitions .....	6
Adoption of Annex .....	6
Implementation of Annex .....	6
Language .....	6
Editorial Note .....	6
<b>PART I. — DEFINITIONS AND PHRASEOLOGY</b>	
CHAPTER 1.—Definitions .....	9
CHAPTER 2.—Phraseology .....	11
2.1.—Runways and Channels .....	11
<b>PART II. — GENERAL</b>	
CHAPTER 1.—Introduction .....	13
CHAPTER 2.—Aerodrome Data .....	13
2.1.—Aerodrome Reference Point .....	13
2.2.—Aerodrome Elevation .....	13
CHAPTER 3.—Reference Codes for Aerodrome Characteristics .....	14
3.1.—Land Aerodromes .....	14
3.2.—Water Aerodromes .....	15
<b>PART III. — PHYSICAL CHARACTERISTICS OF AERODROMES</b>	
CHAPTER 1.—Land Aerodromes with Runways .....	17
1.1.—Runways .....	17
1.2.—Strips .....	19
1.3.—Taxiways .....	19
1.4.—Aprons .....	21
CHAPTER 2.—Water Aerodromes with Channels .....	21
2.1.—Channels .....	21
2.2.—Turning Basins .....	23
2.3.—Taxi-Channels .....	23
2.4.—Mooring Areas .....	23
<b>PART IV. — AERONAUTICAL GROUND LIGHT AND SURFACE MARKING COLOURS</b>	
1.1.—General .....	25
1.2.—Colours for Aeronautical Ground Lights .....	25
1.3.—Colours for Surface Markings .....	27

## TABLE OF CONTENTS (contd.)

	<i>Page</i>
<b>PART V. — OBSTRUCTION CLEARING AND MARKING</b>	
CHAPTER 1.—Obstruction Clearing and Marking Surfaces and Areas . . . . .	33
1.1.—Land Aerodromes with Runways . . . . .	33
1.2.—Water Aerodromes with Channels . . . . .	34
CHAPTER 2.—Clearing and Restriction of Obstructions . . . . .	36
2.1.—Obstruction Clearing . . . . .	36
2.2.—Restriction of new Construction . . . . .	36
CHAPTER 3.—Obstruction Marking . . . . .	37
3.1.—Aerodromes with Runways or Channels . . . . .	37
3.2.—Day Marking of Obstructions . . . . .	37
3.3.—Lighting of Obstructions . . . . .	38
3.4.—Marking of Unserviceable Portions of the Movement Area . . . . .	40
<b>PART VI. — VISUAL GROUND AIDS</b>	
CHAPTER 1.—General . . . . .	41
1.1.—Dangerous and Confusing Lights . . . . .	41
1.2.—Indicators . . . . .	41
1.3.—Signalling Devices . . . . .	42
1.4.—Emergency Lighting . . . . .	44
1.5.—Aids to Location . . . . .	44
CHAPTER 2.—Land Aerodromes with Runways . . . . .	45
2.1.—Day Marking Aids . . . . .	45
2.2.—Lighting Aids . . . . .	51
CHAPTER 3.—Water Aerodromes . . . . .	56
3.1.—Aids to Landing . . . . .	56
3.2.—Aids to Taxying . . . . .	58
CHAPTER 4.—Land Aerodromes without Runways . . . . .	59
4.1.—Day Marking Aids . . . . .	59
4.2.—Lighting Aids . . . . .	59
<b>PART VII. — AERODROME EQUIPMENT</b>	
CHAPTER 1.—Emergency Power Supply . . . . .	61
1.1.—Application . . . . .	61
1.2.—Characteristics . . . . .	61
<b>ATTACHMENTS</b>	
ATTACHMENT A.—Illustrations and Explanatory Diagrams . . . . .	63
ATTACHMENT B.—Information and Material for Guidance in the Application of the Standards and Recommended Practices in Annex 14 . . . . .	73
HISTORICAL NOTE ON THE DEVELOPMENT OF ANNEXES TO THE CONVENTION . . . . .	79

## FOREWORD

### Introduction

This document contains International Standards and Recommended Practices pursuant to Article 37 of the Convention on International Civil Aviation (Chicago 1944). These Standards and Recommended Practices became **effective on 1 November 1951**.

They will **come into force** as follows:

a) in the case of aerodromes used as regular or alternate aerodromes by international air services: **on 1 June 1952**;

b) in the case of all other aerodromes used or intended to be used for the operation of aircraft engaged in international air navigation: **on 1 January 1954**.

The Standards and Recommended Practices as now presented have undergone the following stages of development:

At the Chicago (1944) Conference, Annex A to the Convention was developed. This was subsequently reviewed and amended at the First Session of the PICAQ Subcommittee on Airways Systems, Landing Areas and Ground Aids (LAG) in 1945, and at the Second Session of the Aerodromes, Air Routes and Ground Aids Division (AGA) in 1946. In September 1947 the Division, at its Third Session, developed and submitted the material in the form of recommendations for Standards and Recommended Practices which were forwarded to States for comment in the first quarter of 1948.

The Air Navigation Commission during 1949 further developed the proposed Standards and Recommended Practices and then resubmitted them to States, together with additional recom-

mendations made in November 1949 by the AGA Division at its Fourth Session, for comment by October 1950. Still further development was made by the Air Navigation Commission on the basis of States' comments and the resulting proposals were adopted by the Council as Annex 14.

Attention is drawn to the title adopted for the Annex, viz. "Aerodromes". Use of this title is not intended to imply that the Annex contains all the Standards and Recommended Practices relating to aerodromes. The terms *Air Routes* and *Ground Aids* have been omitted from the title, the former because no such specifications have been adopted, and the latter because, when coupled with *aerodromes*, it does not adequately describe the contents and purpose of the Annex.

The contents of this Annex apply to:

a) all aerodromes in territories under the jurisdiction of a Contracting State that are used as regular or alternate aerodromes by international air services; and

b) all other aerodromes in territories under the jurisdiction of a Contracting State that are used or intended to be used for the operation of aircraft engaged in international air navigation.

It is important that the provisions of this Annex be applied, at the earliest practicable date, to all these aerodromes. Nevertheless, it is recognized that a considerable time may elapse before a Contracting State can apply all the specifications of the Annex in respect of all the aerodromes referred to above. For this reason, and in view of their greater importance to international aviation, Council has given priority to implementing the Annex in respect of the aerodromes under a) above and has allowed one year in which to apply the specifications. In the case of aero-

dromes included under *b*) above, a longer period has been allowed.

The interpretation of some of the specifications in the Annex expressly requires the exercising of discretion, the taking of a decision or the performance of a function by the Competent Authority. In other specifications, the expression *Competent Authority* does not actually appear although its inclusion is implied. In both cases, the responsibility for whatever determination or action is necessary rests with the State having jurisdiction over the aerodrome or the person or agency through which the State exercises its power in the matter concerned.

### Definitions

In order to ensure uniform interpretation of the terms "Standard" and "Recommended Practice", which are not specifically defined in the Convention, the Council has promulgated the following definitions which apply to this Annex:

*Standard*: Any specification for physical characteristics, configuration, matériel, performance, personnel or procedure, the uniform application of which is recognized as necessary for the safety or regularity of international air navigation and to which Contracting States will conform in accordance with the Convention; in the event of impossibility of compliance, notification to the Council is compulsory under Article 38.

*Recommended Practice*: Any specification for physical characteristics, configuration, matériel, performance, personnel or procedure, the uniform application of which is recognized as desirable in the interest of safety, regularity or efficiency of international air navigation, and to which Contracting States will endeavour to conform in accordance with the Convention.

*Notes* which do not alter the meaning of the Standards and Recommended Practices have been included in certain cases where it was necessary to clarify an intention, to stress a particular point or to indicate that a particular question is under study.

### Adoption of Annex

Standards and Recommended Practices for Aerodromes were adopted by the Council on

29 May 1951 and designated as Annex 14 to the Convention. The Annex was submitted forthwith to each Contracting State together with a copy of the Resolution of Adoption by the Council.

On 1 November 1951, which was the date set by the Council for the notification by States of disapproval of the Annex in whole or in part under Article 90, only five States had registered disapproval of any part of the Annex. The Annex accordingly became effective on that date.

### Implementation of Annex

It is expected that by 1 June 1952 States will have introduced the provisions of the Annex at aerodromes used as regular or alternate aerodromes by international services, and that by 1 January 1954 States will have introduced the provisions of the Annex at all other aerodromes used or intended to be used for the operation of aircraft engaged in international air navigation.

Attention is invited to the Introduction (Part II, Chapter 1) regarding the review by ICAO Regional Air Navigation Meetings of the need for specific installations on the basis of which the Council formulates policy and forwards recommendations to the Contracting States concerned.

### Language

The Standards and Recommended Practices for Aerodromes, being an Annex to the Convention, exist and are officially circulated in three languages — English, French and Spanish.

Pursuant to Council action on 6 December 1948, each Contracting State has been requested to select one of those texts for the purpose of national implementation and for other effects provided for in the Convention, either through direct use or through translation into its own national language, and to notify the Organization accordingly.

### Editorial Note

The following practice has been adhered to in order to indicate at a glance the status of each statement: *Standards* have been printed in bold face type; *Recommended Practices* have been printed in light face type, the status being indi-

cated by the prefix *RECOMMENDATION*; *Notes* have been printed in small type italics, the status being indicated by the prefix *Note*.

Throughout this document measurements are given in the metric system followed in paren-

theses by corresponding measurements in the foot-pound system.

Any reference to a portion of this document, which is identified by a number, includes all subdivisions of such portion.



**THIS PAGE INTENTIONALLY LEFT BLANK**

# International Standards and Recommended Practices

## AERODROMES

### PART I.—DEFINITIONS AND PHRASEOLOGY

#### CHAPTER 1. — DEFINITIONS

When the following terms are used in the Standards and Recommended Practices for Aerodromes, they have the following meanings:

*Aerodrome.* A defined area on land or water (including any buildings, installations and equipment) intended to be used either wholly or in part for the arrival, departure and movement of aircraft.

*Aerodrome beacon.* Aeronautical beacon used to indicate the location of an aerodrome.

*Aerodrome elevation.* The elevation of the highest point of the landing area.

*Aerodrome identification sign.* A sign placed on or adjacent to an aerodrome to aid in identifying the aerodrome from the air.

*Aerodrome reference point.* The designated geographical location of an aerodrome.

*Aeronautical beacon.* An aeronautical ground light visible at all azimuths, either continuously or intermittently, to designate

a particular point on the surface of the earth.

*Aeronautical ground light.* Any light specially provided as an aid to air navigation, other than a light displayed on an aircraft.

*Angle-of-approach lights.* Aeronautical ground lights arranged so as to indicate the desired angle of descent during an approach to an aerodrome.

*Approach lighting system.* A configuration of aeronautical ground lights in the approach area to a runway or channel intended to assist a pilot in making an approach to that runway or channel.

*Apron.* A defined area, on a land aerodrome, intended to accommodate aircraft for purposes of loading or unloading passengers or cargo, refuelling, parking or maintenance.

*Boundary lights.* Aeronautical ground lights delimiting the boundary of a landing area.

**Boundary markers.** Markers used to indicate the boundary of a landing area.

**Channel.** A defined rectangular area on a water aerodrome, intended for the landing and take-off run of aircraft along its length.

**Channel lights.** Aeronautical ground lights arranged along the sides of a channel.

**Density altitude.** An atmospheric density expressed in terms of the altitude which corresponds to that density in the standard atmosphere.

**Fixed light.** A light having constant luminous intensity when observed from a fixed point.

**Hazard beacon.** An aeronautical beacon used to designate a danger to air navigation.

**Identification beacon.** An aeronautical beacon emitting a coded signal by means of which a particular point of reference can be identified.

**Instrument channel.** A channel intended for the operation of aircraft using non-visual aids.

**Instrument runway.** A runway intended for the operation of aircraft using non-visual aids.

**Landing area.** The part of the movement area intended for the landing or take-off run of aircraft.

**Landing direction indicator.** A device to indicate visually the direction currently designated for landing and for take-off.

**Low water level.** The average low level during that month of the year when levels are lowest or, in the case of tidal waters, the average level of low water springs or lower low waters, depending on the type of tide.

**Main channel.** The channel determined as such by the Competent Authority.

**Main channel selected basic length.** The length selected by the Competent Authority as the basis for the design of a given water aerodrome.

**Main runway.** The runway determined as such by the Competent Authority.

**Main runway selected basic length.** The length selected by the Competent Authority as the basis for the design of a given land aerodrome.

**Markers.** Objects, other than landing direction indicators, wind direction indicators and flags, used to indicate obstructions or to convey aeronautical information by day.

**Markings.** Signs displayed on surfaces in order to convey aeronautical information.

**Movement area.** That part of an aerodrome intended for the surface movement of aircraft.

**Obstruction lights.** Aeronautical ground lights provided to indicate obstructions.

**Runway.** A defined rectangular area, on a land aerodrome selected or prepared for the landing and take-off run of aircraft along its length.

**Runway lights.** Aeronautical ground lights arranged along a runway indicating its direction or boundaries.

**Runway threshold markings.** Markings so placed as to indicate the longitudinal limits of that portion of the runway usable for landing.

**Signal area.** An area on an aerodrome used for the display of ground signals.

**Signalling lamp.** A device used for directing light signals at individual targets.

**Taxi-channel.** A defined path, on a water aerodrome, intended for the use of taxiing aircraft.

**Taxi-channel lights.** Aeronautical ground lights arranged along a taxi-channel to indicate the route to be followed by taxiing aircraft.

**Taxi-holding position.** A designated position at which taxiing aircraft may be required to stop.

**Taxiway.** A defined path, on a land aerodrome, selected or prepared for the use of taxiing aircraft.

**Taxiway lights.** Aeronautical ground lights arranged along a taxiway to indicate the

route to be followed by taxiing aircraft.

**Threshold lights.** Aeronautical ground lights so placed as to indicate the longitudinal limits of that portion of a runway, channel or landing path usable for landing.

## CHAPTER 2. — PHRASEOLOGY

### 2.1.—RUNWAYS AND CHANNELS

**2.1.1**           Wherever a Standard or Recommended Practice in this Annex is marked with an asterisk, it applies at least to those runways or channels that are needed at a particular aerodrome to satisfy the specification entitled “Number and orienta-

tions” (see Part III, 1.1.1 and 2.1.1), unless otherwise indicated in a particular context.

**2.1.2**           Wherever a specification regarding runways or channels is not marked with an asterisk, it applies to all the runways or all the channels provided at every aerodrome to which the Annex relates, unless otherwise indicated in a particular context.

**THIS PAGE INTENTIONALLY LEFT BLANK**

## PART II.—GENERAL

### CHAPTER 1. — INTRODUCTION

*Note.*—This Annex contains Standards and Recommended Practices that prescribe the physical and associated characteristics to be possessed by and the equipment to be provided at aerodromes used or intended to be used for the operation of aircraft engaged in international air navigation.

Its contents are not yet complete but arrangements have been made for the inclusion in appropriate Chapters of additional material dealing with aerodromes of types other than those now covered e.g., land aerodromes without runways, water aerodromes without channels, helicopter aerodromes, etc.

It does not include Standards relating to the location, siting, size or capacity of particular aerodromes or separation between adjacent aerodromes to avoid conflicting traffic patterns, since Contracting States will determine these factors, taking into consideration the air traffic such aerodromes are intended to serve. Council periodically reviews the requirements of international air navigation for aerodromes and formulates ICAO

opinion and recommendations to Contracting States concerning them, ordinarily on the basis of the recommendations of Regional Air Navigation Meetings.

The Annex contains specifications that prescribe the appropriate relationship between a number of different physical characteristics, according to the particular type or size of aerodrome under consideration. These inter-related specifications, when grouped in the prescribed manner, provide a series of design criteria for efficiently proportioned aerodromes. The groups of specifications are sufficiently wide in their scope to cover the needs of international air traffic both now and in the foreseeable future. As will be seen from Chapter 3 in this Part, a code system is used in various parts of the Annex to facilitate reference.

It also contains specifications concerning the clearing and marking of obstructions on and in the vicinity of aerodromes and concerning the visual ground aids and other facilities necessary on aerodromes for the safe and efficient operation of aircraft engaged in international air navigation.

### CHAPTER 2. — AERODROME DATA

*Note.*—This Chapter contains specifications requiring the determination by the Competent Authority of data about aerodromes. The manner in which the required data is to be published is not prescribed in this Annex.

#### 2.1.—AERODROME REFERENCE POINT

**2.1.1** The Competent Authority shall determine the position of the aerodrome reference point selected for each aerodrome.

**2.1.2** The position of the aerodrome reference point shall be permanently established and shall be given in terms of the nearest second of latitude and longitude.

**2.1.3** The position of the aerodrome reference point shall be as near to the geometric centre of the landing area as is practicable and consistent with 2.1.2, taking possible future development of the aerodrome into account.

#### 2.2.—AERODROME ELEVATION

**2.2.1** The Competent Authority shall determine the aerodrome elevation.

**2.2.2** The aerodrome elevation shall be given in terms of the nearest metre or foot.

## CHAPTER 3. — REFERENCE CODES FOR AERODROME CHARACTERISTICS

*Note.*—This Chapter contains definitive material establishing the meaning of various reference code letters and numbers; the code letters and numbers are given in tables that are followed by explanatory notes. The use of code letters and, to a lesser extent, code numbers, with the meanings assigned to them in this chapter simplifies the drafting of certain specifications contained in Parts III, V and VI of the Annex. The specifications in which code letters or code numbers are used are those that are interrelated with what are known as an aerodrome's principal physical character-

istics, namely main runway length and strength and main channel length and depth. Values have to be selected by the Competent Authority for certain specified principal physical characteristics in the manner prescribed in Part III of the Annex before the interrelated specifications can be interpreted in the case of a particular aerodrome.

The code letters and code numbers in the tables in this Chapter are not suitable for use as an aerodrome or runway classification system, such as might be useful in air navigation.

### 3.1.—LAND AERODROMES

**3.1.1** Code letters when used in this Annex in connection with land aerodromes, have the meanings assigned to them in Table 1.

**3.1.2** Code numbers when used in this Annex in connection with land aerodromes, have the meanings assigned to them in Table 2.

Table 1

Code Letter	Main runway selected basic length
A	2,550 m (8,400 ft) and over
B	2,150 m (7,000 ft) up to but not including 2,550 m (8,400 ft)
C	1,800 m (5,900 ft) “ “ “ “ “ 2,150 m (7,000 ft)
D	1,500 m (5,000 ft) “ “ “ “ “ 1,800 m (5,900 ft)
E	1,280 m (4,200 ft) “ “ “ “ “ 1,500 m (5,000 ft)
F	1,080 m (3,500 ft) “ “ “ “ “ 1,280 m (4,200 ft)
G	900 m (3,000 ft) “ “ “ “ “ 1,080 m (3,500 ft)

*Note.*—The dimensions shown in this table are in no way intended to restrict the actual length of the main or other runways (see Part III, 1.1.2 and Attachment B, Section 4, for a description of the application of this table both to new aerodromes and to existing aerodromes).

Table 2

Code Number	Selected single isolated wheel load	Associated tire pressure
(1)	(2)	(3)
1	45,000 kgs. (100,000 lbs)	See Attachment B
2	35,000 kgs. ( 75,000 lbs)	
3	27,000 kgs. ( 60,000 lbs)	
4	20,000 kgs. ( 45,000 lbs)	
5	13,000 kgs. ( 30,000 lbs)	
6	7,000 kgs. ( 15,000 lbs)	
7	2,000 kgs. ( 5,000 lbs)	

*Note.*—Column (2) of this table gives a selection of fixed values of single isolated wheel load. At present, the selection of the appropriate tire pressure to be associated with the selected wheel load is left to the Competent Authority (see Attachment B, Section 7, for guidance).

## 3.2.—WATER AERODROMES

**3.2.1** Code letters when used in this Annex in connection with water aerodromes, have the meanings assigned to them in Table 3.

**3.2.2** Code numbers when used in this Annex in connection with water aerodromes, have the meanings assigned to them in Table 4.

Table 3

<b>Code Letter</b>	<b>Main channel selected basic length</b>
<b>A</b>	<b>4,500 m (15,000 ft) and over</b>
<b>B</b>	<b>3,000 m (10,000 ft) up to but not including 4,500 m (15,000 ft)</b>
<b>C</b>	<b>2,000 m ( 6,500 ft) up to but not including 3,000 m (10,000 ft)</b>

*Note.*—The dimensions shown in this table are in no way intended to restrict the actual length of the main or other channels (see Part III, 2.1.2 and also Attachment B, Section 4, for a description of the application of this table both to new aerodromes and to existing aerodromes).

Table 4

<b>Code Number</b>	<b>Main channel selected depth</b>
<b>1</b>	<b>4.5 m (15 ft) and over</b>
<b>2</b>	<b>3.7 m (12 ft) up to but not including 4.5 m (15 ft)</b>
<b>3</b>	<b>2.4 m ( 8 ft) up to but not including 3.7 m (12 ft)</b>

*Note 1.*—The depth of a channel is the minimum depth of water at low water level that is to be expected anywhere in the channel.

*Note 2.*—The dimensions shown in the table are in no way intended to restrict the actual depth of the main or other channels.



**THIS PAGE INTENTIONALLY LEFT BLANK**

## PART III. — PHYSICAL CHARACTERISTICS OF AERODROMES

### CHAPTER 1. — LAND AERODROMES WITH RUNWAYS

*Note.*—This Chapter deals with land aerodromes with a main runway selected basic length of not less than 900 metres (3,000 feet).

*Inter-relationship of certain of the specifications contained in this Chapter — use being made of the code system for this purpose — and inclusion of specifications containing suitable quantitative requirements, aim at ensuring the maximum all-round usefulness of an aerodrome without incurring disproportionate construction and maintenance expenditure.*

*The requisite inter-relationship is achieved by assuming two characteristics, namely main runway selected basic length and strength, as principal characteristics and by linking specifications for other characteristics to them, in the manner indicated in this Chapter.*

*Appropriate values for the two principal characteristics are to be selected by the Competent Authority, having regard to the needs of air traffic that the aerodrome is intended to serve. Quantitative specifications for the characteristics that are related to the two principal characteristics will be found in the relevant paragraphs that follow.*

#### 1.1.—RUNWAYS

1.1.1 RECOMMENDATION. — *Number and orientation.* The number of runways at an aerodrome and their orientation should be such that for as large a percentage of time as practicable but for not less than 95 per cent there is at least one runway for which the surface wind velocity component at right angles to its longitudinal axis will not preclude the landing or taking-off of aircraft that the aerodrome is intended to serve.

*Note.*—In Attachment B, Section 2, guidance is given on the acceptable values of cross-wind components.

1.1.2 RECOMMENDATION. — *Main runway length.* The length of the main runway at an aerodrome should be not less than the main runway selected basic length together with:

1) an additional length to be determined in accordance with 1.1.2.2 where the temperature and pressure at the site differ from sea level standard atmospheric conditions;

2) a further additional length in respect of longitudinal slopes (if any), to be determined in accordance with 1.1.2.3.

*Note.*—See Attachment B, Sections 3, 4 and 5.

1.1.2.1 RECOMMENDATION. — *Main runway selected basic length.* The main runway selected basic length should be the length that would actually be required at a level site at sea level in standard atmospheric conditions to meet the present and estimated future needs of the air traffic that the aerodrome is intended to serve.

*Note.*—The code letter appropriate to the main runway selected basic length is to be found in Part II, Chapter 3, Table 1.

1.1.2.2 RECOMMENDATION. — *Additional length for differences from sea level standard atmospheric conditions.* Additional length for differences from sea level standard atmospheric conditions should be calculated at the rate of 5 per cent of the main runway selected basic length for every 300 metres (1,000 feet) of density altitude, except that in cases where

particularly high temperature or humidity conditions occur, a method of calculation, taking temperature, pressure and humidity into account independently, should be used. The value selected as the density altitude of a site should be the mean of the highest density altitudes occurring on each day in the hottest month of the year (*i.e.* the month which has the highest mean of daily maximum temperature) averaged over a period of years.

*Note.*—Attachment B, 5.1 gives the methods used by certain States in determining the additional length required, taking into account altitude and temperature independently.

**1.1.2.3** RECOMMENDATION. — *Additional length for longitudinal slopes.* The additional length to be provided when longitudinal slopes occur either along the whole runway or along portions of it should be determined with due consideration to specific slopes and their positions along the runway.

*Note.*—In view of the many variables involved, it is not possible to recommend, for general application, a method of determining the additional length required. Attachment B, 5.2, gives the methods used by certain States in determining the additional length required, in the case of uniform longitudinal slopes along the whole runway.

**1.1.3 \*** RECOMMENDATION. — *Length of runways other than the main runway.* The length of runways other than the main runway should be not less than 85 per cent of the main runway selected basic length, together with an additional length for differences from sea level standard atmospheric conditions determined as specified in 1.1.2.2, and together with a further additional length in respect of longitudinal slopes (if any) determined as specified in 1.1.2.3, except that in the case of a runway or runways provided to take account of the effects of particular winds of high velocities, the ratio of reduction may be lowered from 85 per cent to a minimum of 70 per cent.

**1.1.4 \*** RECOMMENDATION. — *Width.* The width of runways at an aerodrome should be not less than:

60 metres (200 feet) where the code letter is A or B,

45 metres (150 feet) where the code letter is C, D or E,

30 metres (100 feet) where the code letter is F or G.

\* See Part I, 2.1.1.

**1.1.5** RECOMMENDATION. — *Separation of parallel runways.* Where parallel runways are provided for simultaneous use under visual conditions only, the minimum distance between their centre lines should be:

210 metres (700 feet) where the code letter is A, B or C,

150 metres (500 feet) where the code letter is D, E, F or G.

*Note.*—Much greater separation will be necessary when parallel runways are provided for simultaneous use under any other conditions.

**1.1.6 \*** *Slopes on runways.*

**1.1.6.1** RECOMMENDATION. — *Longitudinal slopes.* The slope of a straight line joining the centre points of the extremities of a runway should not exceed 1 per cent. Along no portion of a runway should the longitudinal slope exceed:

1.25 per cent where the code letter is A or B,

1.5 per cent where the code letter is C, D, E, F or G.

**1.1.6.2** RECOMMENDATION. — *Longitudinal slope changes.* Where slope changes cannot be avoided, the transition from one slope to another should be accomplished by a curved surface with a rate of change not exceeding 0.3 per cent per 30 metres (100 feet).

*Note.*—This is equivalent to a minimum radius of curvature of 10,000 metres (33,000 feet).

**1.1.6.3** RECOMMENDATION. — *Sight distance.* Where slope changes cannot be avoided, they should be such that there will be an unobstructed line of sight from any point 3 metres (10 feet) above the runway to all other points 3 metres (10 feet) above the runway within a distance of at least half the length of the runway.

**1.1.6.4** RECOMMENDATION. — *Distance between slope changes.* Frequent undulations or appreciable changes in slope located close together along a runway should be avoided. The distance between two successive transition curves should be not less than the sum of the absolute numerical values of the corresponding grade changes multiplied by 7,500 metres (25,000 feet).

*Note.*—See Attachment B, Section 6, for example.

\* See Part I, 2.1.1.

1.1.6.5 RECOMMENDATION. — *Transverse slopes.* The transverse slopes of a runway should be such as to prevent the accumulation of water on the surface of the runway, but should not exceed 1.5 per cent.

1.1.7 \* RECOMMENDATION. — *Strength of runways.* Runways should be capable of withstanding the traffic of aircraft imposing a value of single isolated wheel load selected by the Competent Authority from Table 2, Part II, 3.1.2 at a tire pressure chosen by the Competent Authority that together would produce stresses at least equivalent to those resulting from such aircraft as the aerodrome is intended to serve. The frequency of operations assumed should be the maximum expected at the aerodrome of aircraft of the kind producing such stresses, but should be not less than 10 operations per day.

*Note 1.*—Attachment B, Section 7, gives guidance regarding the tire pressure to be associated with the selected value of single isolated wheel load.

*Note 2.*—One operation is either a landing or a take-off.

## 1.2.—STRIPS

1.2.1 \* Each runway shall be included in a strip. The surface of that portion of the strip that abuts the runway shall be flush with the surface of the runway.

1.2.2 \* RECOMMENDATION. — *Length.* The strip should extend at least 60 metres (200 feet) beyond both ends of the runway it includes.

### 1.2.3 Width.

1.2.3.1 RECOMMENDATION. — *Instrument runways.* The strip including an instrument runway should extend to a distance of at least 150 metres (500 feet) on each side of the centre line of the runway throughout the length of the strip.

1.2.3.2 \* RECOMMENDATION. — *Runways other than instrument runways.* The strip including a runway other than an instrument runway should extend to at least the distance given herein, on each side of the centre line of the runway throughout the length of the strip:

105 metres (350 feet) where the code letter is A, B or C,

75 metres (250 feet) where the code letter is D, E, F or G.

### 1.2.4 \* Slopes.

1.2.4.1 RECOMMENDATION. — *Longitudinal slopes.* The longitudinal slope along any portion of a strip, beyond the limits of the runway it includes, and within a distance of 75 metres (250 feet) from the centre line of the runway, should not exceed:

1.75 per cent where the code letter is A or B,

2 per cent where the code letter is C, D, E, F or G.

1.2.4.2 RECOMMENDATION. — *Longitudinal slope changes.* Slope changes on those portions of the strip, beyond the limits of the runway it includes, should be as gradual as practicable and abrupt changes or sudden reversals of slopes should be avoided.

1.2.4.3 RECOMMENDATION. — *Transverse slopes.* The transverse slopes on any portion of a strip, beyond the limits of the runway it includes, and within a distance of 75 metres (250 feet) from the centre line of the runway, should be adequate to prevent the accumulation of water on the surface, but should not exceed 2.5 per cent. The transverse slopes on those portions of the strip beyond this distance should not exceed 5 per cent.

*Note.*—It is not intended that the portions of the strip beyond a distance of 75 metres (250 feet) from the centre line of the runway be necessarily prepared to the same extent as the portions within this distance, but rather that they be clear of hazards to aircraft.

1.2.5 \* RECOMMENDATION.—*Strength.* Those portions of the strip immediately beyond the limits of the runway should be so prepared or constructed as to minimize hazards, arising from differences in load bearing capacity, to an aircraft running off the runway.

## 1.3.—TAXIWAYS

1.3.1 RECOMMENDATION.—*General.* Taxiways should be provided to permit the safe and expeditious handling of aerodrome

\* See Part I, 2.1.1.

\* See Part I, 2.1.1.

traffic. When so provided the following provisions of this section apply.

1.3.2 RECOMMENDATION. — *Changes in direction.* Taxiways should be straight for as great a proportion of their length as is practicable. Where changes in direction are necessary, the radius of curvature of the taxiway centre line should be not less than 1.5 times the width of the taxiway.

1.3.3 RECOMMENDATION. — *Width.* Taxiways should have a width of not less than:

30 metres (100 feet) where the code letter is A,

23 metres (75 feet) where the code letter is B or C,

18 metres (60 feet) where the code letter is D,

15 metres (50 feet) where the code letter is E,

12.5 metres (40 feet) where the code letter is F or G.

1.3.4 RECOMMENDATION. — *Fillets.* Fillets should be provided at the junction or intersection of taxiways with runways, aprons and other taxiways, as necessary to facilitate the movement of aircraft. The radius of the fillet should

be not less than the taxiway width. Where two taxiways having unequal widths join or cross, the width of the wider taxiway should govern the minimum radius of curvature of the fillet.

### 1.3.5 Minimum clearances.

1.3.5.1 RECOMMENDATION. — The distance between any point on the centre line of a taxiway and the centre line of a runway should be not less than the appropriate dimension specified in columns 2 and 3 of the following table, except that this does not apply within a radius of 1.5 times the specified distance, from the point of intersection of the centre lines of a taxiway and a runway.

1.3.5.2 RECOMMENDATION. — The distance between any point on the centre line of a taxiway and the centre line of another taxiway should be not less than the appropriate dimension specified in column 4 of the following table, except that this does not apply within a radius as near as practicable to 1.5 times the specified distance, from the point of intersection of the centre lines of two taxiways.

1.3.5.3 RECOMMENDATION. — The distance between any point on the centre line of a taxiway and a fixed obstruction should be not less than the appropriate dimension given in column 5 of the following table.

(1)	(2)		(3)		(4)		(5)	
Land Aerodrome Code Letter	Distance between any point on the centre line of a taxiway and the centre line of a runway				Distance between any point on the centre line of one taxiway and the centre line of another taxiway		Distance between any point on the centre line of a taxiway and a fixed obstruction	
	Instrument runway		Runway other than an instrument runway					
	Metres	Feet	Metres	Feet	Metres	Feet	Metres	Feet
A	210	700	165	550	100	325	54	180
B	195	650	150	500	90	300	50	165
C	180	600	135	450	75	250	42	140
D	180	600	105	350	75	250	38	125
E	180	600	105	350	60	200	30	100
F	165	550	90	300	45	150	30	100
G	165	550	90	300	38	125	24	80

1.3.5.4 RECOMMENDATION. — In the case of a taxiway serving the end of a runway, the taxiway should, where practicable, be at right angles to the runway, for the first 30 metres (100 feet) from the edge of the runway.

### 1.3.6 Slopes.

1.3.6.1 RECOMMENDATION. — *Longitudinal slopes.* The longitudinal slope of taxiways should be as small as practicable and should not exceed 3 per cent.

1.3.6.2 RECOMMENDATION. — *Longitudinal slope changes.* Where slope changes on taxiways cannot be avoided, the transition from one slope to another slope should be accomplished by a curved surface with a rate of change not exceeding 1 per cent per 30 metres (100 feet).

*Note.*—This is equivalent to a minimum radius of curvature of 3,000 metres (10,000 feet).

1.3.6.3 RECOMMENDATION. — *Sight distance.* Where slope changes on taxiways cannot be avoided, they should be such that from any point 3 metres (10 feet) above the taxiway it will be possible to see the whole surface of the taxiway for a distance of 300 metres (1,000 feet) from that point.

1.3.6.4 RECOMMENDATION. — *Transverse slope.* The transverse slope of taxiways should be such as to prevent the accumulation of water on the surface of the taxiway but should not exceed 1.5 per cent.

1.3.7 RECOMMENDATION.—*Strength.* The strength of taxiways should be at least that of the runways they serve, due consideration being given to the fact that taxiways, as compared with runways, will be subjected to a greater density of traffic and to higher stresses that result from slow moving or stationary aircraft.

*Note.*—In Attachment B, Section 8, guidance is given on the relation of the strength of taxiways to the strength of runways.

## 1.4.—APRONS

1.4.1 RECOMMENDATION. — *General.* Aprons should be provided as and when necessary to permit the on- and off-loading of passengers, cargo or mail without interfering with the aerodrome traffic.

1.4.2 RECOMMENDATION. — *Size.* The total apron area should be adequate to permit expeditious handling of the air traffic at its maximum anticipated density.

1.4.3 RECOMMENDATION.—*Strength.* Each part of an apron should be capable of withstanding the traffic of the aircraft it is intended to serve, due consideration being given to the fact that aprons, as compared with runways, will be subjected to a greater density of traffic and to higher stresses that result from slow moving or stationary aircraft.

*Note.*—In Attachment B, Section 8, guidance is given on the relation of the strength of aprons to the strength of runways.

## CHAPTER 2. — WATER AERODROMES WITH CHANNELS

*Note.*—This Chapter deals with water aerodromes with a main channel selected basic length of not less than 2,000 metres (6,500 feet).

*Inter-relationship of certain of the specifications contained in this Chapter — use being made of the code system for this purpose — and inclusion of specifications containing suitable quantitative requirements ensure the maximum all-round usefulness of an aerodrome without incurring disproportionate expenditure.*

*The requisite inter-relationship is achieved by assuming two characteristics, namely main channel selected basic length and depth, as principal characteristics and linking specifications for other characteristics to them, in the manner indicated in this Chapter.*

*Appropriate values for the two principal characteristics are to be selected by the Competent Authority, having regard to the needs of air traffic that the aerodrome is intended to serve. Quantitative specifications for the characteristics that are related to the two principal characteristics will be found in the relevant paragraphs that follow.*

### 2.1.—CHANNELS

2.1.1 RECOMMENDATION. — *Number and orientation.* The number of channels at a water aerodrome and their orientation should

be such that, for as large a percentage of time as practicable but for not less than 95 per cent there is at least one channel for which the surface wind velocity component at right angles to its longitudinal axis will not preclude the landing or taking-off of aircraft that the aerodrome is intended to serve.

*Note.*—In Attachment B, Section 2, guidance is given on the acceptable values of cross-wind components.

**2.1.2** RECOMMENDATION. — *Main channel length.* The length of the main channel at a water aerodrome should be not less than the main channel selected basic length, together with an additional length to be determined in accordance with 3.1.2.2 where the temperature and pressure at the site differ from sea level standard atmospheric conditions.

*Note.*—See Attachment B, Sections 3, 4 and 5.

**2.1.2.1** RECOMMENDATION. — *Main channel selected basic length.* The main channel selected basic length should be the length that would actually be required at sea level in standard atmospheric conditions to meet the present and future needs of the air traffic that the aerodrome is intended to serve.

*Note.*—The code letter appropriate to the main channel selected basic length is to be found in Part II, Chapter 3, Table 3.

**2.1.2.2** RECOMMENDATION. — *Additional length for differences from sea level standard atmospheric conditions.* Additional length to be provided for differences from sea level standard atmospheric conditions should be calculated at the rate of 5 per cent of the main channel selected basic length for every 300 metres (1,000 feet) of density altitude, except that in cases where particularly high temperature or humidity conditions occur, a method of calculation taking temperature, pressure and humidity into account independently, should be used. The value selected as the density altitude of a site should be the mean of the highest density altitude occurring on each day in the hottest month of the year (*i.e.* the month which has the highest mean of daily maximum temperature) developed over a period of years.

*Note.*—Attachment B, 5.1, gives the methods used by certain States in determining the additional length required, taking into account altitude and temperature independently.

**2.1.3 \*** RECOMMENDATION. — *Length of channels other than the main channel.* The length of channels other than the main channel should be not less than 85 per cent of the main channel selected basic length, together with an additional length for differences from sea level standard atmospheric conditions determined as specified in 2.1.2.2.

#### **2.1.4** *Width.*

**2.1.4.1 \*** RECOMMENDATION. — The width of channels other than instrument channels should be not less than the value given herein:

225 metres (750 feet) where the code letter is A,

180 metres (600 feet) where the code letter is B,

150 metres (500 feet) where the code letter is C,

except that when the currents within the channel do not exceed two and one-half knots in any direction and when the component of any current at any location within the channel does not exceed one knot in a direction at right angles to the channel, the minimum width may be reduced by 30 metres (100 feet).

**2.1.4.2** RECOMMENDATION. — Where instrument channels are provided, they should have a minimum width of 225 metres (750 feet), irrespective of the main channel selected basic length.

**2.1.5 \*** RECOMMENDATION. — *Depth.* The depth of channels, measured at low water level, should be not less than that shown in the table hereunder:

4.5 metres (15 feet) where the code number is 1,

3.7 metres (12 feet) where the code number is 2,

2.4 metres (8 feet) where the code number is 3,

except that in waters where the wave or swell heights normally exceed 0.75 metre (2.5 feet), the minimum depth of channels at water aerodromes at which the code number is 1 should be increased to 5.5 metres (18 feet).

\* See Part I, 2.1.1.

**2.2.\*—TURNING BASINS**

2.2.1 RECOMMENDATION. — *General.*  
Turning basins should be provided at both ends of channels.

2.2.2 RECOMMENDATION. — *Size.*  
Turning basins should have a diameter measured at low water level of not less than twice the specified minimum width of the corresponding channel.

2.2.3 RECOMMENDATION. — *Depth.*  
The depth of turning basins measured at low water level should be at least that of the corresponding channel.

**2.3.—TAXI-CHANNELS**

2.3.1 RECOMMENDATION. — *General.*  
Taxi-channels should be provided to permit the safe and expeditious handling of aerodrome traffic. When so provided the following provisions of this section apply.

2.3.2 RECOMMENDATION. — *Width.*  
Taxi-channels should have a width measured at low water level of not less than:

120 metres (400 feet) where the code letter is A,

\* See Part I, 2.1.1.

105 metres (350 feet) where the code letter is B,

90 metres (300 feet) where the code letter is C.

2.3.3 RECOMMENDATION. — *Depth.*  
Taxi-channels should have a depth, measured at low water level, of not less than:

3.6 metres (12 feet) where the code number is 1,

2.7 metres (9 feet) where the code number is 2,

1.8 metres (6 feet) where the code number is 3.

**2.4.—MOORING AREAS**

2.4.1 RECOMMENDATION. — *General.*  
Mooring areas should be provided for the mooring of aircraft and to permit the on- and off-loading of passengers, cargo and mail without interfering with the aerodrome traffic.

2.4.2 RECOMMENDATION. — *Size.*  
The size of the mooring areas should be adequate to permit expeditious handling of the air traffic at its maximum anticipated density.

2.4.3 RECOMMENDATION. — *Depth.*  
The depth of water at a mooring area, measured at low water level should be at least that of the corresponding taxi-channel.



**THIS PAGE INTENTIONALLY LEFT BLANK**

## PART IV. — AERONAUTICAL GROUND LIGHT AND SURFACE MARKING COLOURS

### 1.1.—GENERAL

1.1.1 The following specifications define the chromaticity limits of colours to be used for aeronautical ground lights and for the marking of surfaces as required in this Annex.

1.1.2 It is not possible to establish specifications for colours such that there is no possibility of confusion. For reasonably certain recognition, it is important that the eye illumination should be well above the threshold of perception, that the colour should not be greatly modified by selective atmospheric attenuations and that the observer's colour vision be adequate. There is also a risk of confusion of colour at an extremely high level of eye illumination such as may be obtained from a high intensity source at very close range. Experience indicates that satisfactory recogni-

tion can be achieved if due attention is given to these factors.

1.1.3 The chromaticities are expressed in terms of the standard observer and coordinate system adopted by the International Commission on Illumination (CIE) at its Eighth Session at Cambridge, England, in 1931.\*

*Note.*—Since the CIE coordinate system does not represent chromaticity differences uniformly, a parallel note has been included giving the approximate equivalent limits in the Rectangular-Uniform-Chromaticity-Scale system.\*\* In deriving these approximate equivalents, deviations not exceeding 0.003 for both  $x''$  and  $y''$  have been allowed in order to keep the equations simple.

\* Recommandations officielles de la Commission internationale de l'Éclairage (Huitième Session, 1931). Résolutions: 1 (pages 19, 20 et 21); 4 (page 23) et 5 (pages 24, 25 et 26).

\*\* Proceedings of the International Commission on Illumination, Tenth Session, 1939. Condensed unofficial version edited and published by the United States National Committee (pages 81 and 92-94).

### 1.2.—COLOURS FOR AERONAUTICAL GROUND LIGHTS

1.2.1 The chromaticities of aeronautical ground lights shall be within the following limits (see Figure 1):

#### CIE Equations

*i) Red*

Purple limit  $x + y \geq 0.985$   
Yellow limit  $y \leq 0.335$

*ii) Yellow*

Red limit  $y \geq 0.400$   
Green limit  $y \geq 0.560$   
White limit  $x + y \geq 0.985$

*Note.*—The following equations are approximate equivalents of the Standards (see Figure 2):

#### R-U-C-S Equations

$$\Delta x'' = 0.075 - x''$$

$$x'' \geq 0.071$$

$$y'' \leq -0.317 + 4 \Delta x''$$

$$y'' \geq -0.194 + 4 \Delta x''$$

$$y'' \leq -0.134 - 3 \Delta x''$$

$$x'' \geq 0.072$$

iii) *Variable-yellow*

Red limit	$y \geq 0.385$
Green limit	$x \geq 0.550$
White limit	$x + y \geq 0.985$

$$y'' \geq -0.220 + 4 \Delta x''$$

$$y'' \leq -0.120 - 3 \Delta x''$$

$$x'' \geq 0.072$$

iv) *Green*

Yellow limit	$x \leq 0.390 - 0.171 y$
White limit	$x \leq 0.100 + 0.410 y$
Blue limit	$y \geq 0.390 - 0.171 x$

$$x'' \leq 0.585 y''$$

$$y'' \geq 0.080 - 0.172 x''$$

$$x'' \geq -0.150 y''$$

v) *Blue*

Green limit	$y \leq 0.060 + 0.820 x$
White limit	$y \leq 0.480 - x$
Purple limit	$x \leq 0.167 + 0.500 y$

$$x'' \leq -0.965 y''$$

$$x'' \leq -0.075 + 0.250 y''$$

$$y'' \geq -0.025 x''$$

Note.—This specification permits the use of blue filters of higher transmission than does 1.2.2.

vi) *White*

Yellow limit	$x \leq 0.470$
Blue limit	$x \geq 0.350$
Green limit	$y \leq 0.150 + 0.640 x$
Purple limit	$y \geq 0.050 + 0.750 x$

$$x'' \leq 0.090 + 0.500 y''$$

$$x'' \geq 0.015 + 0.750 y''$$

$$x'' \leq 0.020 - 0.700 y''$$

$$x'' \geq -0.026 - 0.900 y''$$

vii) *Variable-white*

Yellow limit	$x \leq 0.560$
Blue limit	$x \geq 0.350$
Green limit	$y \leq 0.150 + 0.640 x$
and	$y \leq 0.640 - 0.400 x$
Purple limit	$y \geq 0.050 + 0.750 x$
or	$y \geq 0.250 + 0.250 x$

$$x'' \leq 0.115 + 0.300 y''$$

$$x'' \geq 0.015 + 0.750 y''$$

$$x'' \leq 0.020 - 0.700 y''$$

$$\text{and } x'' \leq 0.055 - 0.100 y''$$

$$x'' \geq -0.026 - 0.900 y''$$

$$\text{or } x'' \geq -0.385 y''$$

1.2.2 RECOMMENDATION. — Blue lights should have chromaticities within the following limits (see Figure 1):

*CIE Equations*

White limit	$y \leq 0.400 - x$
Purple limit	$x \leq 0.133 + 0.600 y$

Note.—The following equations are approximate equivalents of the Recommended Practice (see Figure 2):

*R-U-C-S Equations*

$$x'' \leq -0.125 + 0.333 y''$$

$$y'' \geq -0.205 x''$$

Note.—The more restricted area specified above assures a greater probability of recognition of the colour whereas the area specified in 1.2.1 (V) permits filters of higher transmission to be used.

1.2.3 *Discrimination between yellow and white lights.*

1.2.3.1 RECOMMENDATION. — If yellow and white are to be discriminated from each other, they should be displayed in close proximity

of time or space as, for example, by being flashed successively from the same beacon.

Note.—The limits of yellow and white have been based on the assumption that they will be used in situations in which the characteristics (colour temperature) of the light source will be substantially constant.

1.2.3.2 RECOMMENDATION. — The colours variable-yellow and variable-white are intended to be used only for lights that are to be varied in intensity, *e.g.*, to avoid dazzling. If these colours are to be discriminated from each other, the lights should be so designed and operated that:

a) the chromaticity of the yellow lights will be represented by coordinates such that

$y$  is not greater than  $x - 0.160$  at any time when the chromaticity of the white lights is represented by coordinates of which  $x$  is greater than 0.470; and

b) the disposition of the lights will be such that the yellow lights are displayed simultaneously and in close proximity to the white lights.

### 1.3.—COLOURS FOR SURFACE MARKINGS

1.3.1 RECOMMENDATION. — When viewed normally and illuminated at an angle of incidence of 45 degrees by "Illuminant C" as defined by the International Commission on Illumination\*, the chromaticity of a surface marking and its luminous directional reflectance (luminance factor) *i.e.* the relative luminance (brightness) of the surface compared with that of a magnesium oxide surface, should be within the following limits (*see* Figure 3):

*Note.—The following equations are approximate equivalents of the Recommended Practices (see Figure 4):*

CIE Equations	Luminous directional reflectance (luminance factor)	R-U-C-S Equations
<i>i) Red</i>		
Orange limit $y \leq 0.350$	0.075 (min.)	$x'' \leq 0.004 - 0.250 y''$
Purple limit $x + y \geq 0.950$		$x'' \geq 0.067 + 0.015 y''$
<i>ii) Orange</i>		
Red limit $y \geq 0.350$	0.100 (min.)	$x'' \geq 0.004 - 0.250 y''$
Yellow limit $y \leq 0.390$		$x'' \leq 0.022 - 0.250 y''$
Purple limit $x + y \geq 0.950$		$x'' \geq 0.067 + 0.015 y''$
<i>iii) Yellow</i>		
Orange limit $y \geq 0.390$	0.250 (min.)	$x'' \geq 0.022 - 0.250 y''$
Green limit $y \leq x - 0.050$		$y'' \leq -0.035 - 0.700 x''$
Purple limit $x + y \geq 0.950$		$x'' \geq 0.067 + 0.015 y''$
<i>iv) White</i>		
$0.290 \leq x \leq 0.340$	0.70 (min.)	$x'' \geq -0.047 + y''$
$0.290 \leq y \leq 0.340$		$x'' \leq 0.003 - 0.250 y''$
		$x'' \leq 0.007 + 0.900 y''$
		$x'' \geq -0.022 - 0.250 y''$
<i>v) Black</i>		
$0.290 \leq x \leq 0.340$	0.04 (max.)	$x'' \geq -0.047 + y''$
$0.290 \leq y \leq 0.340$		$x'' \leq 0.003 - 0.250 y''$
		$x'' \leq 0.007 + 0.900 y''$
		$x'' \geq -0.022 - 0.250 y''$

*Note 1.—It is preferable that the chromaticity of yellow be such that  $y \geq 0.350x + 0.215$  ( $x'' \geq -0.450y''$ ).*

*Note 2.—Colours used for surface marking are liable to change with time. Whilst it is not feasible to require maintenance in accordance with strict mathematical limits, due diligence should be exercised to ensure that surfaces are renewed whenever they have changed colour noticeably.*

\* Recommendations officielles de la Commission internationale de l'Éclairage (Huitième Session, 1931; Résolution 2 (pages 19 et 22).

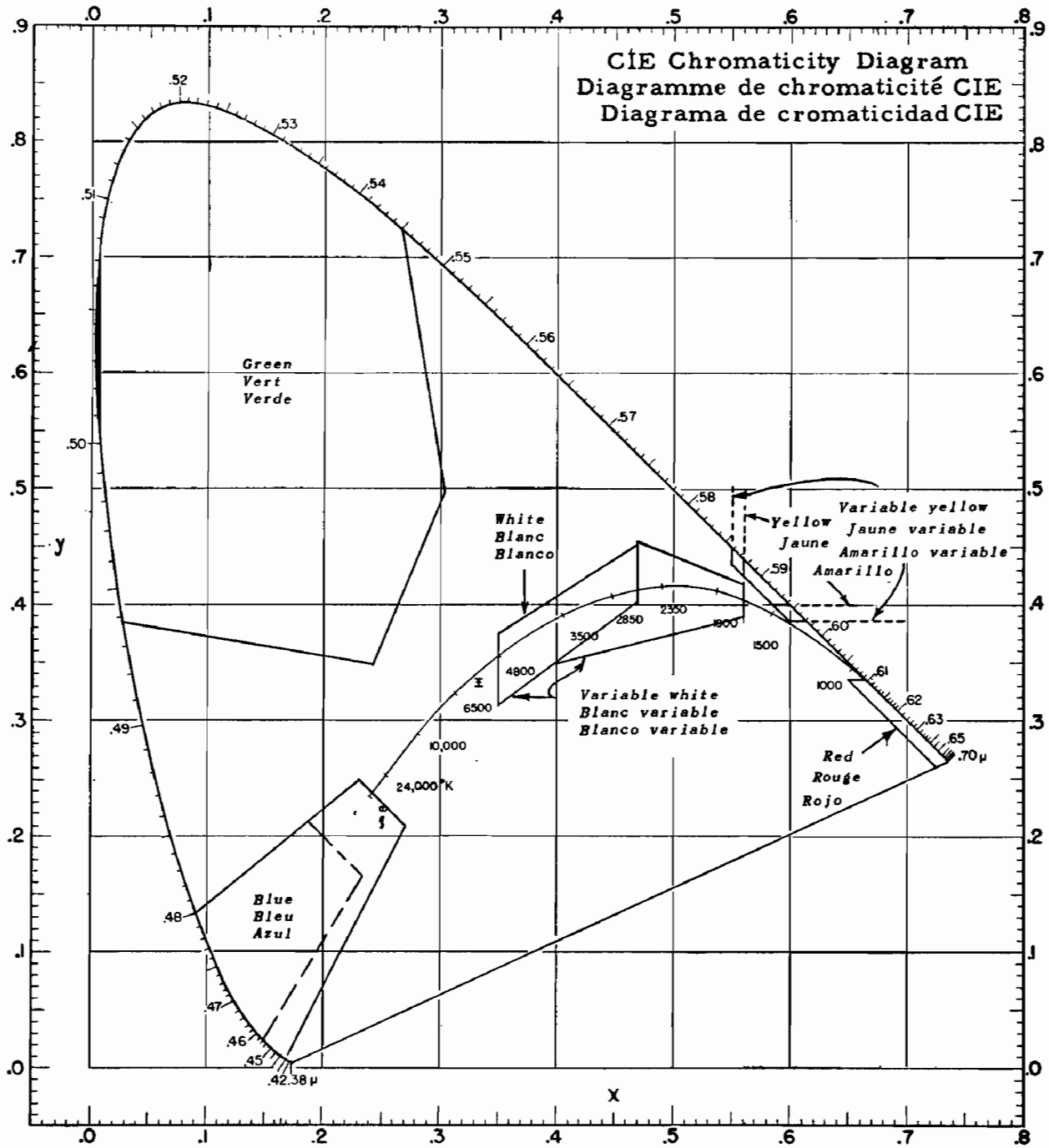

{
Equal energy  
Point d'égale énergie  
Punto de equienergía

Fig. 1.—Colours for Aeronautical Ground Lights (ICAO Limits)

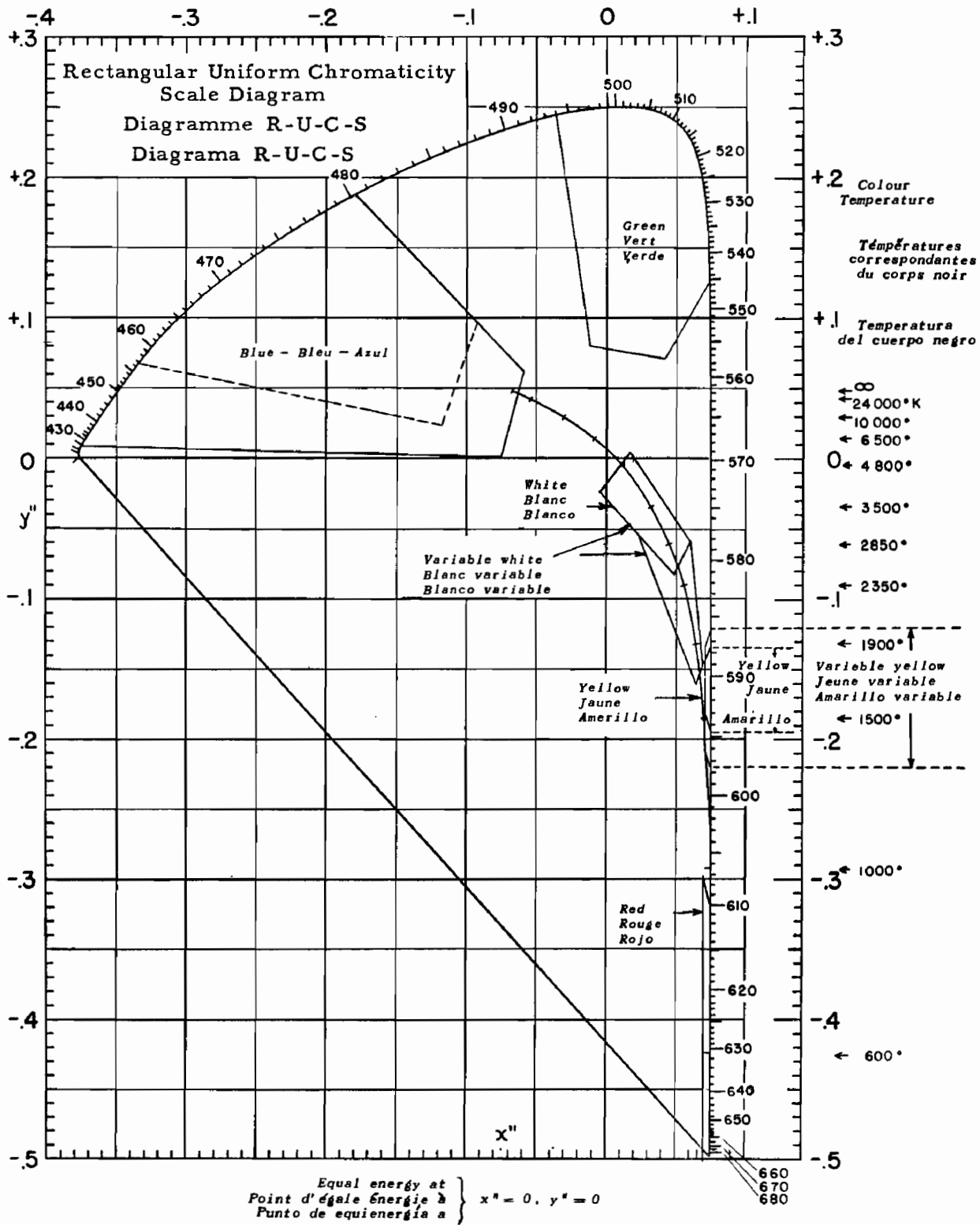

Fig. 2.—Approximate Equivalents of Colours for Aeronautical Ground Lights (ICAO Limits)

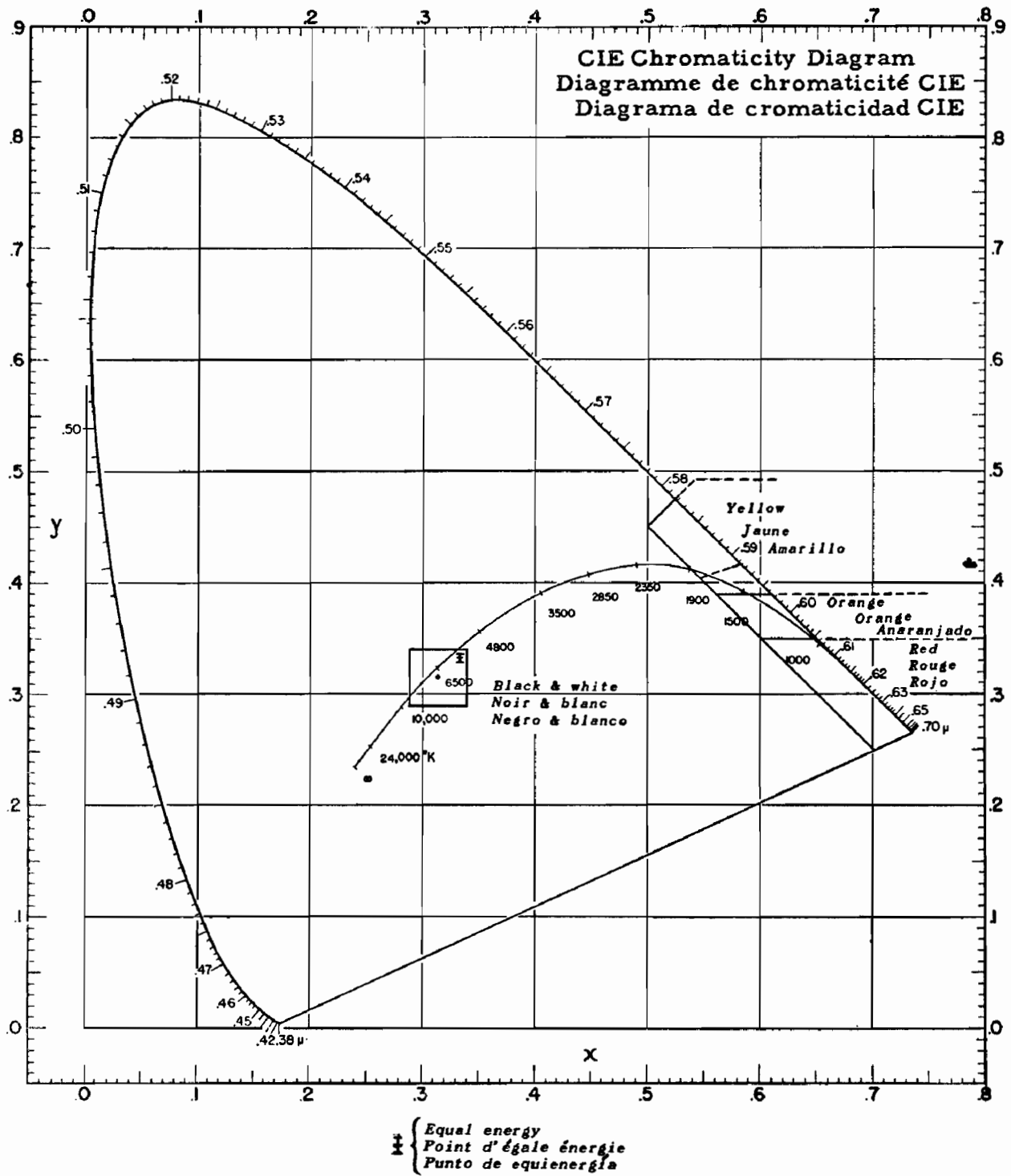
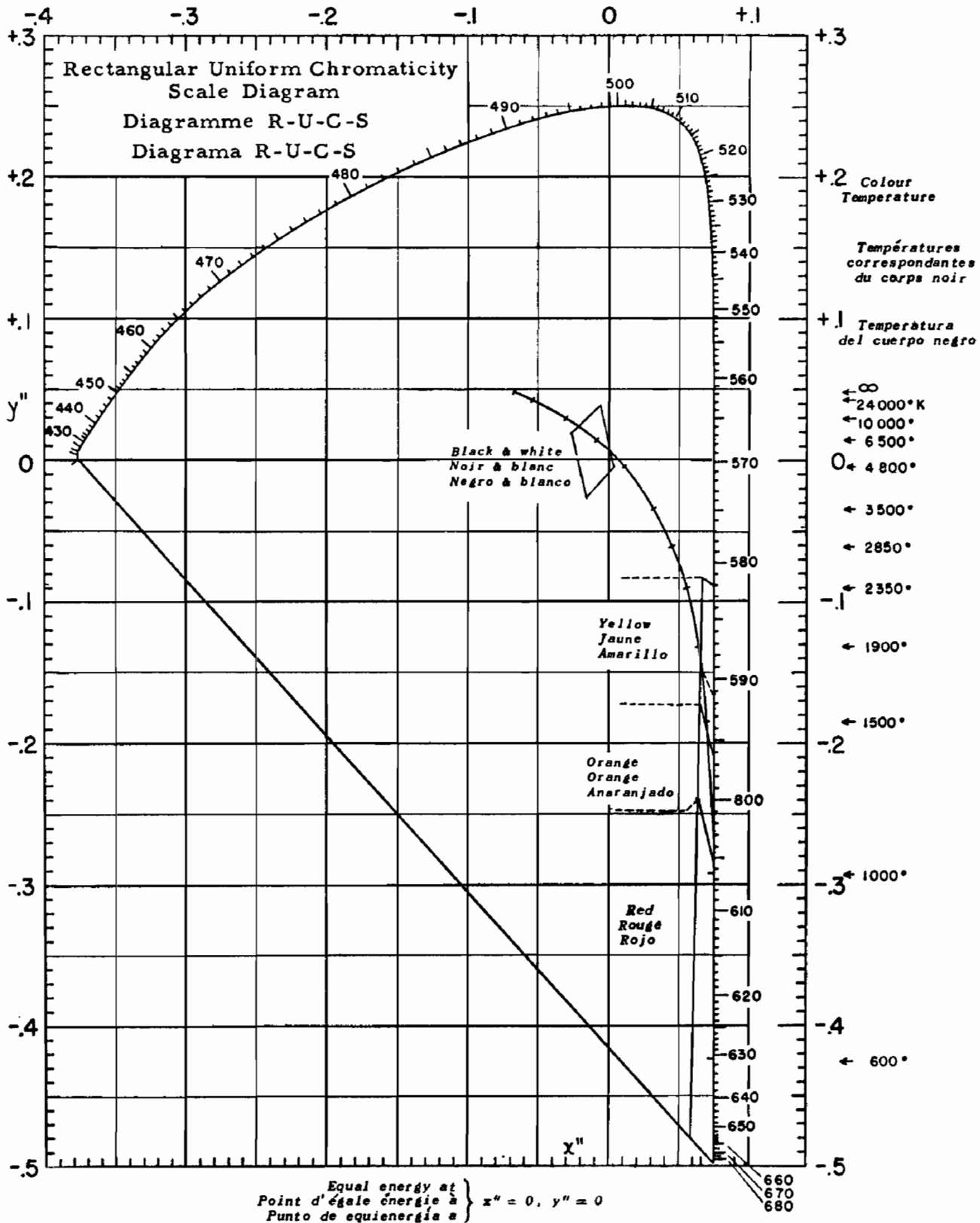

Fig. 3.—Colours for Surface Markings (ICAO Limits)



Recommended practice: ————— Preferred limit for yellow: - - - - -

Fig. 4.—Approximate Equivalents of Colours for Surface Markings (ICAO Limits)



**THIS PAGE INTENTIONALLY LEFT BLANK**

## PART V. — OBSTRUCTION CLEARING AND MARKING

### CHAPTER 1. — OBSTRUCTION CLEARING AND MARKING SURFACES AND AREAS

(See Figures 17, 18, 19, 20 and 21 in Attachment A)

When the following terms are used in this Annex they have the following meanings.

#### 1.1.—LAND AERODROMES WITH RUNWAYS

##### 1.1.1 \* *Approach areas.*

1.1.1.1 An approach area is a portion of the surface of the ground (or water) at the end of a runway. There are two approach areas to a runway, one at each end of it. Each approach area is quadrilateral in shape and its projection onto a horizontal plane is symmetrical about the vertical plane containing the extended centre line of the runway. Two sides are contained in vertical planes perpendicular to the

\* See Part I, 2.1.1.

vertical plane containing the centre line of the runway and the other two sides converge toward the runway.

1.1.1.2 The inner edge of each approach area is at a distance of 60 metres (200 feet) measured horizontally from the end of the runway.

1.1.1.3 The dimensions of each approach area, when projected onto a horizontal plane, are as indicated herein.

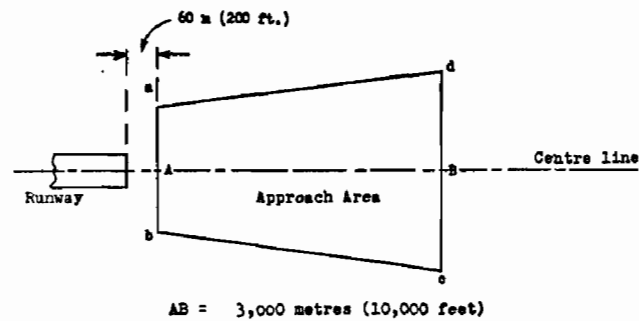

<i>Instrument runways</i>	<i>Runways other than instrument runways at aerodromes at which the main runway code letter is:</i>	
	A, B or C	D, E, F or G
ab      300 m (1,000 ft)	210 m ( 700 ft)	150 m ( 500 ft)
cd      1,200 m (4,000 ft)	750 m (2,500 ft)	750 m (2,500 ft)

### 1.1.2 \* Approach surfaces.

1.1.2.1 An approach surface is a portion of an inclined plane with limits vertically above the limits of the corresponding approach area. The lower limit of each approach surface is a horizontal line at right angles to the vertical plane containing the centre line of the runway.

1.1.2.2 Each approach surface passes through a point on the ground or water located at the intersection of the inner edge of the corresponding approach area with the vertical plane containing the centre line of the runway. The slope, measured in the vertical plane containing the centre line of the runway, is:

- 1) 1:50 for instrument runways;
- 2) 1:40 for runways other than instrument runways where the code letter is A, B, C or D;
- 3) 1:30 for runways other than instrument runways where the code letter is E or F;
- 4) 1:25 for runways other than instrument runways where the code letter is G.

1.1.3 *Horizontal surface.* The horizontal surface is contained in a horizontal plane located 45 metres (150 feet) above the mean level of the landing area and its outer limits are at a horizontal radius of at least 4,000 metres (13,000 feet) from the approximate geometric centre of the landing area.

*Note.—The outer limits of the horizontal surface determined by the minimum radius prescribed in 1.1.3 may require extension in the case of large aerodromes with unusual layouts.*

### 1.1.4 \* Transitional surfaces.

1.1.4.1 The transitional surfaces slope upwards and outwards from the edges of the approach surfaces and from the edges of the prescribed minimum strip, till they intersect the horizontal surface.

*Note.—Minimum strip width is prescribed in Part III, 1.2.3.*

1.1.4.2 The slope of these transitional surfaces, measured in a vertical plane perpendicular to the vertical plane containing the axis of each runway, is 1:7.

\* See Part I, 2.1.1.

### 1.1.5 Conical surface.

1.1.5.1 The conical surface slopes upwards and outwards from the periphery of the horizontal surface.

1.1.5.2 The slope of the conical surface, measured in any vertical plane passing through the approximate geometric centre of the landing area, is 1:20.

1.1.5.3 The outer limits of the conical surface are contained in a horizontal plane located:

- 1) 100 metres (350 feet) above the horizontal surface where the code letter is A or B,
- 2) 50 metres (150 feet) above the horizontal surface where the code letter is C, D or E.

*Note.—There is no provision made for a conical surface at aerodromes where the code letter is F or G.*

## 1.2.—WATER AERODROMES WITH CHANNELS

### 1.2.1 \* Approach areas.

1.2.1.1 An approach area is a portion of the ground (or water) at the end of a channel. There are two approach areas to a channel, one at each end of it. Each approach area is quadrilateral in shape and its projection onto a horizontal plane is symmetrical about the extended centre line of the channel. Two sides are contained in vertical planes perpendicular to the vertical plane containing the centre line of the channel and the other two sides converge toward the channel.

1.2.1.2 The inner edge of each approach area is coincident with the end of the channel.

1.2.1.3 The dimensions of each approach area, when projected onto a horizontal plane are as indicated herein.

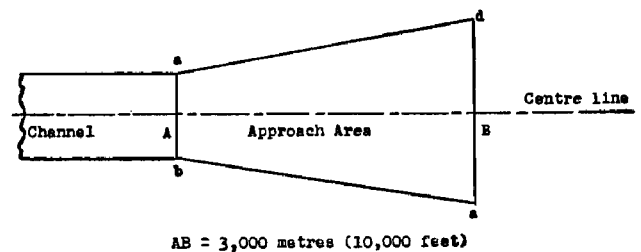

\* See Part I, 2.1.1.

<i>Instrument channels</i>		<i>Channels other than instrument channels</i>
ab	Channel width	Channel width
cd	Channel width plus 900 metres (3,000 feet)	Channel width plus 600 metres (2,000 feet)

### 1.2.2 \* *Approach surfaces.*

1.2.2.1 An approach surface is a portion of an inclined plane with limits vertically above the limits of the corresponding approach area. The lower limit of each approach surface is the end of the channel at low water level.

1.2.2.2 The slope measured in the vertical plane containing the centre line of the channel is:

- 1) 1:50 for instrument channels,
- 2) 1:40 for channels other than instrument channels where the code letter is A or B,
- 3) 1:30 for channels other than instrument channels where the code letter is C.

1.2.3 *Horizontal surface.* The horizontal surface is contained in a horizontal plane located 45 metres (150 feet) above the low water level of the landing area and its outer limits are at a horizontal radius of at least 4,000 metres (13,000 feet) from the approximate geometric centre of the landing area.

*Note.*—The outer limits of the horizontal surface determined by the minimum radius prescribed in 1.2.3 may require extension in the case of large aerodromes with unusual layouts.

### 1.2.4 \* *Transitional surfaces.*

\* See Part I, 2.1.1.

1.2.4.1 The transitional surfaces slope upwards and outwards from the edges of the approach surface till they intersect the horizontal surface and from the edges of the channels at low water level, till they intersect the horizontal surface.

1.2.4.2 The slope of these transitional surfaces, measured in a vertical plane perpendicular to the vertical plane containing the axis of each channel is 1:7.

### 1.2.5 *Conical surface.*

1.2.5.1 The conical surface slopes upwards and outwards from the periphery of the horizontal surface.

1.2.5.2 The slope of the conical surface, measured in any vertical plane passing through the approximate geometric centre of the landing area, is 1:20.

1.2.5.3 The outer limits of the conical surface are contained in a horizontal plane located:

- 1) 100 metres (350 feet) above the horizontal surface where the code letter is A,
- 2) 50 metres (150 feet) above the horizontal surface where the code letter is B.

*Note.*—There is no provision made for a conical surface at aerodromes where the code letter is C.

## CHAPTER 2. — CLEARING AND RESTRICTION OF OBSTRUCTIONS

### 2.1.—OBSTRUCTION CLEARING

*Note.*—The term "objects" as used in this Chapter includes both temporary and permanent objects.

#### 2.1.1 Land aerodromes with runways.

2.1.1.1 RECOMMENDATION. — At least those objects or portions thereof that extend above the approach or transitional surfaces should be regarded as obstructions and should be removed.

*Note 1.*—In certain cases when the strip has a transverse slope, portions of the lower (horizontal) edge of the approach surface will be below the strip, and objects, or the surface of the strip itself, will be above the approach surface. It is not intended that the strip be graded down to conform with approach surface nor is it intended that objects beyond the end of the strip that are lower than the level of the strip be cleared unless it is considered that they may endanger aircraft.

*Note 2.*—It may be necessary to remove objects or portions thereof, particularly in the case of instrument runways, that:

- a) extend above a plane rising at a slope of 1:40 from the outer limit of the approach surface;
- b) are located within the approach area extended to 8 nautical miles from the end of the runway, and
- c) might endanger aircraft.

*Note 3.*—The removal of objects within a distance of 360 metres (1,200 feet) of the end of a runway which, although they do not amount to obstructions, may nevertheless constitute a danger to aircraft overshooting or undershooting the runway or interfere with the satisfactory operation of visual or non-visual aids to approach and landing, may also be necessary.

2.1.1.2 RECOMMENDATION. — Anything which may endanger aircraft on the movement area or in the air within the limits of the horizontal and conical surfaces should be regarded as an obstruction and should be removed insofar as practicable.

*Note.*—In certain circumstances, objects that do not project above any of the surfaces enumerated in 1.1. constitute a hazard to aircraft as, for example, where there are one or more isolated objects in the vicinity of an aerodrome.

#### 2.1.2 Water aerodromes with channels.

2.1.2.1 RECOMMENDATION. — At least those objects or portions thereof that extend above the approach or transitional surfaces should be regarded as obstructions and should be removed.

*Note 1.*—It may be necessary to remove objects or portions thereof, particularly in the case of instrument channels, that:

- a) extend above a plane rising at a slope of 1:40 from the outer limit of the approach surface;
- b) are located within the approach area extended to 8 nautical miles from the end of the channel, and
- c) might endanger aircraft.

*Note 2.*—The removal of objects within a distance of 300 metres (1,000 feet) of the end of a channel which, although they do not amount to obstructions, may nevertheless constitute a danger to aircraft overshooting or undershooting a channel or interfere with the satisfactory operation of visual or non-visual aids to approach and landing, may also be necessary.

2.1.2.2 RECOMMENDATION. — Anything which may endanger aircraft on the movement area or in the air within the limits of the horizontal and conical surfaces should be regarded as an obstruction and should be removed insofar as practicable.

*Note.*—In certain circumstances, objects that do not project above any of the surfaces enumerated in 1.2. may constitute a hazard to aircraft as, for example, where there are one or more isolated objects in the vicinity of an aerodrome.

### 2.2.—RESTRICTION OF NEW CONSTRUCTION

2.2.1 New construction which would project above the approach surfaces or transitional surfaces, shall be prohibited.

2.2.2 RECOMMENDATION. — New construction which would project above the horizontal surface should be prohibited.

2.2.3 RECOMMENDATION.—Particularly in the case of instrument runways or channels, new construction which would:

a) project above a plane rising at a slope of 1:40 measured from the outer end of an approach surface,

b) be located within an approach area extended to 8 nautical miles from the end of the runway or channel, and

c) be likely to endanger aircraft, should be prohibited.

## CHAPTER 3. — OBSTRUCTION MARKING

### 3.1.—AERODROMES WITH RUNWAYS OR CHANNELS

*Note.—The term "objects" as used in this section includes both temporary and permanent objects.*

3.1.1 **Obstructions which should be removed in accordance with the Recommended Practices in 2.1.1.1, 2.1.1.2, 2.1.2.1, and 2.1.2.2 shall, if not removed, be marked.**

3.1.2 **Objects or portions thereof within the limits of approach areas that extend above the horizontal surface shall be regarded as obstructions and shall be marked.**

3.1.3 RECOMMENDATION.— Objects or portions thereof that extend above the horizontal surface outside the limits of approach areas but within the radius, measured from the approximate geometric centre of the landing area, specified in the tables hereunder should be regarded as obstructions and should be marked.

*Table 1 — Land aerodromes*

4,000 metres (13,000 feet)	where the code letter is A,
3,500 metres (11,500 feet)	where the code letter is B,
3,000 metres (10,000 feet)	where the code letter is C,
2,500 metres ( 8,500 feet)	where the code letter is D,
2,000 metres ( 7,000 feet)	where the code letter is E,
1,800 metres ( 6,000 feet)	where the code letter is F,

1,500 metres ( 5,000 feet)  
where the code letter is G.

*Table 2 — Water aerodromes*

4,000 metres (13,000 feet)  
where the code letter is A,  
3,000 metres (10,000 feet)  
where the code letter is B,  
1,800 metres ( 6,000 feet)  
where the code letter is C.

3.1.4 **Vehicles on the movement area of a land aerodrome shall be regarded as obstructions and shall be marked.**

### 3.2.—DAY MARKING OF OBSTRUCTIONS

#### 3.2.1 *General.*

3.2.1.1 **All obstructions the marking of which is prescribed in section 3.1 except 3.1.4 shall be marked by colour whenever practicable, but if this is not practicable, markers or flags shall be displayed on or above them, except that:**

a) **obstructions that are sufficiently conspicuous by their shape, size or colour need not be otherwise marked;**

b) **such parts of obstructions as are shielded by surrounding objects need not be marked but the surrounding objects shall be marked.**

3.2.1.2 **The marking of vehicles prescribed in 3.1.4 shall be achieved either by colours, by markers or by flags.**

3.2.1.3 **When an elevated type of light is used within the boundary of the**

movement area, it shall be made conspicuous by day by a suitable form of marking and shall be of such construction that its presence does not endanger aircraft.

### 3.2.2 Use of colours.

3.2.2.1 RECOMMENDATION.—Obstructions with essentially unbroken surfaces, the projection of which on any vertical plane exceeds 4.5 metres (15 feet) in both dimensions, should be coloured to show a chequered pattern of orange and white rectangles of not less than 1.5 metres (5 feet) and not more than 3 metres (10 feet) on a side, the corners being orange. (See Figures 23 and 26 in Attachment A.)

3.2.2.2 RECOMMENDATION.—Obstructions with essentially unbroken surfaces, the projection of which on any vertical plane exceeds 1.5 metres (4½ feet) in one dimension, and is less than 4.5 metres (15 feet) in the other dimension, and any skeleton type of obstruction having both dimensions greater than 1.5 metres (4½ feet) should be coloured to show bands of orange and white. The bands should be not less than 0.5 metre (1½ feet) and not more than 6 metres (20 feet) wide and should be perpendicular to the major axis. Bands at the extremities of this type of obstruction should be orange. (See Figures 22, 23, 24, 25, 26 and 27 in Attachment A.)

3.2.2.3 RECOMMENDATION.—Obstructions the projection of which on any vertical plane has both dimensions less than 1.5 metres (4½ feet) should be coloured to show a single conspicuous colour, preferably orange.

3.2.2.4 RECOMMENDATION. — When vehicles are marked by colour, a single conspicuous colour, preferably yellow for service vehicles and red for emergency vehicles should be used.

### 3.2.3 Use of markers.

3.2.3.1 Markers displayed on or adjacent to obstructions shall be located in conspicuous positions so as to retain the general definition of the obstruction and shall be recognizable in clear air from a distance of at least 300 metres (1,000 feet) in all directions in which an aircraft is likely to approach the obstruction. The shape of markers shall be distinctive to the extent necessary to ensure that they are not mis-

taken for markers employed to convey other information, and they shall be such that the hazard presented by the obstruction they mark is not increased.

3.2.3.2 RECOMMENDATION.—Markers displayed on overhead wires should be placed not more than 40 metres (120 feet) apart, with the top of each marker not below the level of the highest wire at the point marked.

3.2.3.3 RECOMMENDATION.—Markers displayed on vehicles should consist of two discs intersecting at right angles. The diameter of the discs should be not less than 0.6 metre (2 feet).

3.2.3.4 RECOMMENDATION.—Markers should be coloured in accordance with the specifications given in 3.2.2. — “Use of colours”.

### 3.2.4 Use of flags.

3.2.4.1 Flags used to mark obstructions shall be displayed around, on top of, or around the highest edge of the obstruction. When flags are used to mark extensive obstructions or groups of closely spaced obstructions, they shall be displayed at least every 15 metres (50 feet). Flags shall not increase the hazard presented by the obstruction they mark.

3.2.4.2 Flags used to mark obstructions shall in no case be less than 0.6 metre (2 feet) square.

3.2.4.3 RECOMMENDATION. — Flags used to mark obstructions should be wholly orange in colour or a combination of two triangular sections, one orange and the other white, except that where such colours merge with the background, other conspicuous colours should be used.

3.2.4.4 Flags used to mark vehicles shall not be less than 0.9 metre (3 feet) square and shall consist of a chequered pattern of orange and white squares; each square having sides of not less than 0.3 metre (1 foot).

## 3.3.—LIGHTING OF OBSTRUCTIONS

3.3.1 *General.* In the case of aerodromes intended for use at night, all

obstructions the marking of which is prescribed in section 3.1 shall be marked by obstruction lights, except that hazard beacons may in special cases be employed instead of or in addition to obstruction lights, in the manner indicated hereafter.

### 3.3.2 Application of obstruction lights and hazard beacons.

**3.3.2.1** Obstruction lights shall be used to indicate the existence of obstructions in approach areas or on movement areas, except that, in cases where an early or special warning is required, one or more hazard beacons shall be provided in the positions in which obstruction lights would normally be displayed.

*Note 1.*—Care must be taken to ensure that hazard beacons do not create disconcerting dazzle.

*Note 2.*—The obstruction light required at a certain position may be omitted when an hazard beacon is provided at that position.

**3.3.2.2** Obstruction lights shall be used to indicate the existence of obstructions located outside approach areas and off the movement area, except that hazard beacons may be used as an alternative to obstruction lights when such obstructions are extensive, e.g. a line of hills, and where the use of obstruction lights would be impracticable or inadequate.

### 3.3.3 Obstruction lights.

**3.3.3.1** *General.* When obstruction lights are used, one or more lights shall be located at the top of the obstruction except in the case of a chimney or other structure of like function (see 3.3.3.2.1). Where the top of an obstruction is more than 45 metres (150 feet) above the level of the surrounding ground, additional lights shall be provided at intermediate levels. The number and arrangement of lights at each level to be marked shall be such that the obstruction is indicated from every angle in azimuth. Where a light is shielded in any direction by an adjacent object, additional lights shall be provided on that object in such a way as to retain the general definition of the obstruction, the shielded light being omitted if it does not contribute to the definition of the obstruction.

*Note.*—Reference to the Standards given in 3.3.3.2 will indicate that the point or edge highest in relation to the obstruction marking surface is to be regarded as the "top of the obstruction". In certain cases, such as when the surface concerned is an approach or transitional surface (i.e. sloping), this point or edge may not be the highest above a horizontal plane passing through the base of the object. In such cases it may, in the interests of safety, be advisable to place additional obstruction light(s) on the highest part of the object as well as on the point or edge highest in relation to the obstruction marking surface.

### 3.3.3.2 Location.

**3.3.3.2.1** The top light or lights shall be so arranged as to mark the point or edge of the obstruction highest in relation to the obstruction marking surface. In the case of a chimney or other structure of like function, the lights shall be placed between 1.5 metres (5 feet) and 3 metres (10 feet) below the top. (See Figures 22, 23, 24, 25 and 26 in Attachment A.)

**3.3.3.2.2** In the case of an extensive obstruction or of a group of closely spaced obstructions, top lights shall be displayed on the points or edges of the obstruction highest in relation to the obstruction marking surface, at intervals of not more than 45 metres (150 feet), so as to indicate the general definition and extent of the obstruction. If two or more edges are of the same height, the edge nearest the landing area shall be marked.

*Note.*—Obstructions consisting of built-up and tree-covered areas are regarded as extensive obstructions.

**3.3.3.2.3** When the top of the obstruction is more than 45 metres (150 feet) above the level of the surrounding ground, an intermediate light or lights shall be provided for each additional 45 metres (150 feet) or fraction thereof. These intermediate lights shall be spaced as equally as practicable between the top light and ground level.

*Note.*—In closely built-up areas the mean elevation of the top of buildings may be used as the equivalent of the ground level.

### 3.3.3.3 Characteristics.

**3.3.3.3.1** Obstruction lights shall be red in colour.

**3.3.3.3.2** RECOMMENDATION.—Obstruction lights should be fixed lights of an intensity of not less than ten candles of red light.



### 3.3.4 Hazard beacons.

**3.3.4.1 General.** When hazard beacons are used, one beacon shall be located on the highest and most prominent feature (in relation to the nearest obstruction marking surface) of the obstruction to be marked. In the case of an extensive obstruction or a group of closely spaced obstructions, additional hazard beacons shall be located at intervals of not more than 900 metres (3,000 feet) on prominent features.

*Note.*—Obstructions consisting of built-up and tree-covered areas are regarded as extensive obstructions.

### 3.3.4.2 Characteristics.

**3.3.4.2.1** Hazard beacons shall show a succession of red flashes. The frequency of flash shall be between 20 and 60 per minute. The peak intensity of the flash shall be not less than 2,000 candles of red light.

**3.3.4.2.2** RECOMMENDATION. — The duration of the flash should exceed that of the dark period.

**3.3.4.2.3** RECOMMENDATION. — In a specific application, a higher intensity than that specified in 3.3.4.2.1, should be adopted if considered desirable for ensuring an adequate degree of protection against the hazard concerned.

## 3.4.—MARKING OF UNSERVICEABLE PORTIONS OF THE MOVEMENT AREA

### 3.4.1 Land Aerodromes.

**3.4.1.1 Day marking.** For day marking purposes, unserviceability markings shall be displayed to indicate any part of the movement area unfit for the movement of aircraft, except that when the unserviceable portion of the movement area is sufficiently small for it to be by-passed by aircraft without affecting the safety of their operation, flags may be used to outline its limits.

### 3.4.1.1.1 Location.

**3.4.1.1.1.1** In the case of runways and taxiways, an unserviceability marking shall be displayed at each end of any unserviceable part.

**3.4.1.1.1.2** RECOMMENDATION. — Unserviceable parts of the movement area other than runways and taxiways should be delineated by markings or flags and where appropriate an unserviceability marking should be placed near the centre of the unserviceable area.

**3.4.1.1.2 Characteristics.** An unserviceability marking shall consist of a cross of the form and minimum dimensions shown in Figure 5 and shall be of a single conspicuous colour, preferably white.

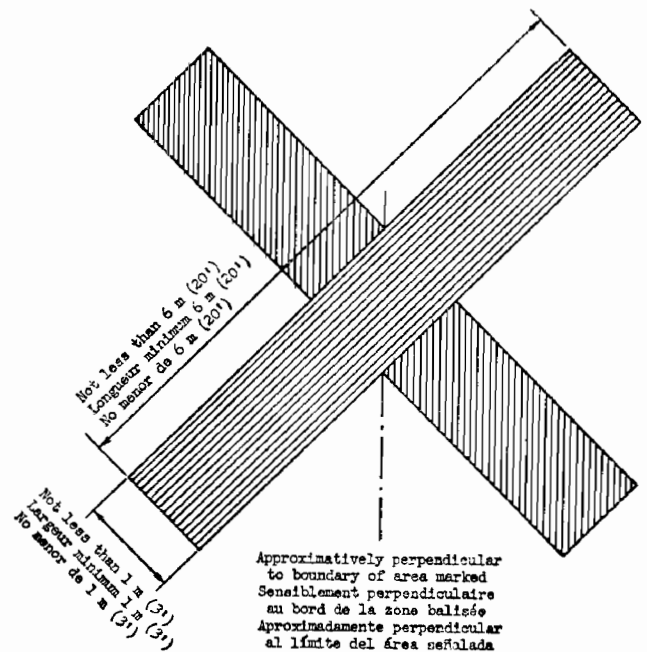

Figure 5. — Unserviceability Marking

**3.4.1.2 Night marking.** When lights are used for delimiting unserviceable portions of the movement area, they shall be fixed red lights.

## PART VI. — VISUAL GROUND AIDS

### CHAPTER 1. — GENERAL

#### 1.1.—DANGEROUS AND CONFUSING LIGHTS

1.1.1 *Lights which endanger the safety of aircraft.* Any light near an aerodrome which is deemed a danger to the safety of aircraft shall be extinguished or so modified as to eliminate the source of danger.

1.1.2 RECOMMENDATION. — *Light which may cause confusion.* All non-aeronautical lights which, by reason of their intensity, configuration or colour, might prevent or cause confusion in the clear interpretation of aeronautical lights should be so screened or otherwise modified as to eliminate such a possibility. In particular, attention should be directed to any lights visible from the air within the areas described herein.

a) At land aerodromes where the code letter is A or B:

within an area extending 750 metres (2,500 feet) on each side of the extended centre line of an instrument runway and for a distance of at least 4,500 metres (15,000 feet) from each end of the runway and within the approach areas of all the other runways.

b) At land aerodromes where the code letter is C, D or E:

as in a), except that the distance from the ends of an instrument runway should be at least 3,000 metres (10,000 feet).

c) At all other land and water aerodromes:

within the approach areas of all runways or channels.

#### 1.2.—INDICATORS

##### 1.2.1 *Wind direction indicators.*

1.2.1.1 All aerodromes shall be equipped with at least one wind direction indicator.

1.2.1.2 RECOMMENDATION. — Provision should be made for illuminating at least one wind direction indicator at each aerodrome intended for use at night.

1.2.1.3 *Location.* Wind direction indicators shall be mounted so as to be visible from aircraft in flight or on the movement area and in such a way as to be free from the effects of air disturbances caused by nearby objects.

##### 1.2.1.4 *Characteristics.*

1.2.1.4.1 RECOMMENDATION. — The wind direction indicator should be in the form of a truncated cone made of fabric.

1.2.1.4.2 RECOMMENDATION. — When in the form of a truncated cone made of fabric:

1) the wind direction indicator should have a length of not less than 3.6 metres (12 feet) and a diameter, at the larger end, of not less than 0.9 metre (3 feet). It should be constructed so that it gives a clear indication of

the direction of the surface wind and a general indication of the wind speed;

2) the colour or colours should be so selected as to make it clearly seen and understood from a height of at least 300 metres (1,000 feet), having regard to background. Where practicable, a single colour, preferably white or orange, should be used. Where a combination of two colours is required to give adequate conspicuity against changing backgrounds, they should preferably be orange and white, or black and white, and should be arranged in five alternate bands, the first and last bands being the darker colour.

1.2.1.4.3 **RECOMMENDATION.** — The location of at least one wind direction indicator provided at a land aerodrome should be marked by a circular band 15 metres (50 feet) in diameter and 1.2 metres (4 feet) wide. The band should be centered about the wind direction indicator support and should be in a colour chosen to give adequate conspicuity, preferably white.

## 1.2.2 **Landing direction indicators.**

1.2.2.1 **When a landing direction indicator is provided, the following specifications of this section apply.**

1.2.2.2 **Provision shall be made for lighting or illuminating landing direction indicators when such devices are provided for use at night.**

1.2.2.3 **Location.** The landing direction indicator shall be located in a conspicuous place on the aerodrome.

1.2.2.4 **RECOMMENDATION.** — *Characteristics.* The landing direction indicator should be a T, a tetrahedron or a launch. If a launch is used, its shape, position and heading should be such that the direction of landing is positively indicated.

1.2.2.5 **Characteristics of a landing T.** The shape and minimum dimensions of a landing T shall be as shown in Figure 6. The colour of the landing T shall be either white or orange arranged against a conspicuous background.

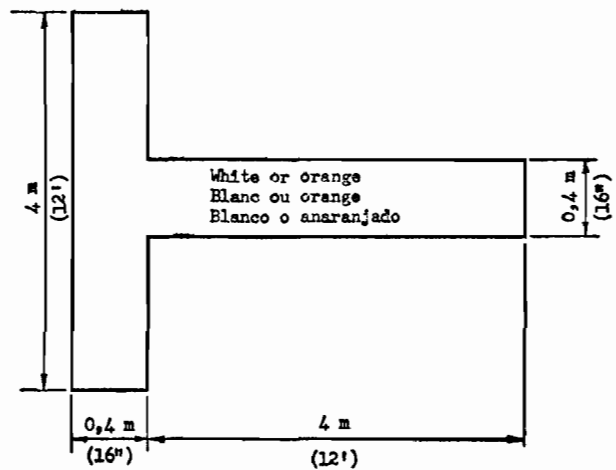

Figure 6. — Landing "T"

1.2.2.6 **Characteristics of the landing tetrahedron.** A landing tetrahedron, when installed, shall have its long axis approximately horizontal.

1.2.2.6.1 **RECOMMENDATION.** — The tetrahedron should have a long axis of not less than 8 metres (25 feet) and an equilateral triangular base with not less than 4-metre (12-foot) sides.

1.2.2.6.2 **When viewing the tetrahedron from the base toward the apex, the left side shall be coloured orange or black and the right side white or aluminum. The landing tetrahedron shall be outlined by lights where required for use at night. When viewing the tetrahedron from the base toward the apex, the ridge, the right edge and the right edge of the base shall be outlined with green lights. Similarly the left edge and the left edge of the base shall be outlined with red lights.**

## 1.3.—SIGNALLING DEVICES

### 1.3.1 **Signalling lamp.**

1.3.1.1 **A signalling lamp shall be provided at all controlled aerodromes.**

### 1.3.1.2 **Characteristics.**

1.3.1.2.1 **RECOMMENDATION.** — The lamp should be capable of producing red, green and white signals, and of:

1) being aimed manually at any target as required;

2) giving a signal in any one colour followed by a signal in either of the two other colours;

3) transmitting a message in any one of the three colours by Morse Code up to a speed of at least four words per minute.

1.3.1.2.2 RECOMMENDATION. — The beam spread should be not less than 1° or greater than 3°. The intensity of the coloured light when used in the daytime should be not less than 6,000 candles. The lamp should be so designed that the

light intensity at angles greater than 3° from the axis of the beam is negligible.

**1.3.2 Ground signal panels and signal area.**

**1.3.2.1** When ground signal panels and a signal area are provided for the purpose of controlling aerodrome traffic, the following specifications apply.

**1.3.2.2 Characteristics of ground signal panels.**

**1.3.2.2.1** Ground signal panels shall be of the types, colours and minimum sizes shown in Figure 7.

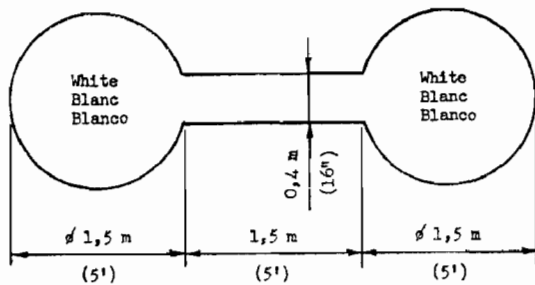

A. - Dumb-bell signal  
Signal en forme d'haltère  
Señal en forma de pesas

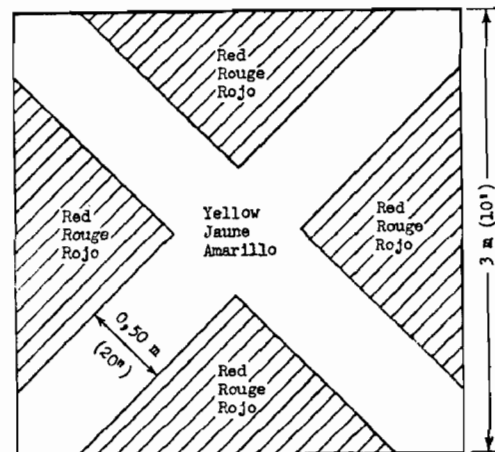

C. - Red square with yellow cross  
Carré rouge à croix jaune  
Cuadrado rojo con cruz en amarillo

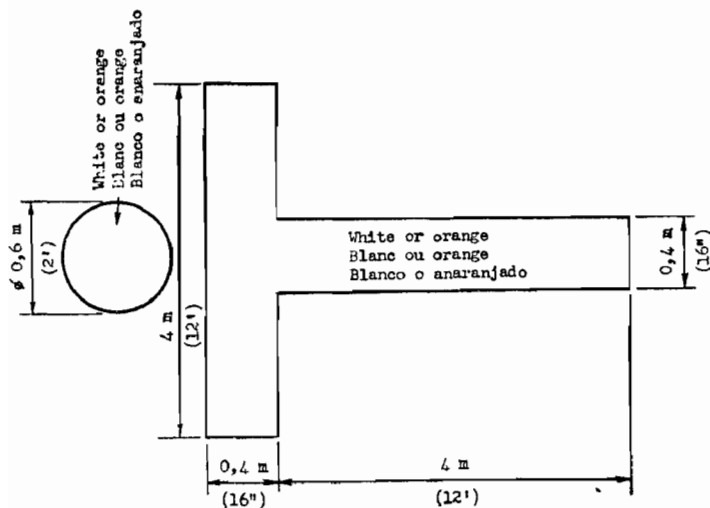

B. - Landing "T"  
"T" d'atterrissage  
"T" de aterrizaje

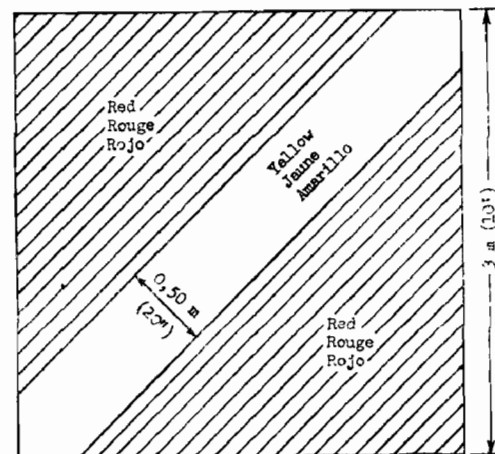

D. - Red square with yellow diagonal  
Carré rouge à diagonale jaune  
Cuadrado rojo con diagonal en amarillo

Note.—See Annex 2 to the Convention on International Civil Aviation regarding the use of these signals.

Figure 7. — Signal Area Panels

### 1.3.2.3 *Characteristics of signal area.*

1.3.2.3.1 The signal area shall be an even horizontal surface at least 9 metres (30 feet) square, surrounded by a white border not less than 0.30 metre (1 foot) wide.

1.3.2.3.2 RECOMMENDATION. — The signal area should be selected or prepared to contrast with red, yellow and white ground signal panels. The area selected should be located so as to be visible in all azimuths above an angle of 10° above the horizontal.

## 1.4.—EMERGENCY LIGHTING

### 1.4.1 *Land aerodromes.*

1.4.1.1 RECOMMENDATION. — Emergency lighting equipment should be available at all land aerodromes intended for use at night, for the purpose of indicating a preferred landing path.

#### 1.4.1.2 *Location.*

1.4.1.2.1 When used to indicate a preferred landing path, the emergency lighting shall be arranged in the form of an inverted "L". The long side shall indicate the edge of the preferred landing path on the left side of the landing aircraft. The short side shall indicate the remote end of the preferred landing path.

1.4.1.2.2 RECOMMENDATION. — Lights along the side of the preferred landing path should be spaced not more than 100 metres (330 feet) apart. The position of the first and last lights in the line should be so arranged that a normal approach or take-off will clear all unlit obstructions. There should be at least two lights placed not more than 60 metres (200 feet) apart to indicate the end of the preferred landing path.

1.4.1.2.3 RECOMMENDATION. — *Characteristics.* Emergency lights should, as near as practicable, show variable-white.

## 1.5.—AIDS TO LOCATION

### 1.5.1 *Aerodrome identification signs.*

1.5.1.1 RECOMMENDATION. — An aerodrome identification sign should be provided at each aerodrome where there is insufficient alternative means of visual identification.

1.5.1.2 RECOMMENDATION.—*Location.* The aerodrome identification sign or signs should be placed on the aerodrome so as to be legible, insofar as practicable, at all angles above the horizontal.

#### 1.5.1.3 *Characteristics.*

1.5.1.3.1 *Form.* Where provided, aerodrome identification signs shall consist of the name of the aerodrome.

1.5.1.3.2 RECOMMENDATION. — *Colour.* The colour selected for aerodrome identification signs should give adequate conspicuity.

1.5.1.3.3 RECOMMENDATION. — *Dimensions.* The characters should be not less than 3 metres (10 feet) high.

#### 1.5.2 *Aerodrome beacons.*

1.5.2.1 An aerodrome beacon shall be provided at each aerodrome intended for use at night.

1.5.2.2 RECOMMENDATION. — *Location.* Aerodrome beacons should be located on or adjacent to the aerodrome.

#### 1.5.3 *Identification beacons.*

##### 1.5.3.1 *Application.*

1.5.3.1.1 RECOMMENDATION.—An identification beacon should be provided at each aerodrome intended for use at night if such aerodrome cannot be easily identified from the air by existing lights or other visual means.

1.5.3.1.2 RECOMMENDATION. — In the case of a combined water and land aerodrome where the aerodrome beacon indicates that the principal facility is a land aerodrome, the water aerodrome section, if used at night, should be provided with an identification beacon, and *vice versa*.

1.5.3.2 *Location.* Where provided, identification beacons shall be located on aerodromes.

**1.5.3.3 Characteristics.**

**1.5.3.3.1 Identification beacons shall show green at land aerodromes and yellow at water aerodromes. The peak intensity shall not be less than 2,000 candles of coloured light.**

**1.5.3.3.2 RECOMMENDATION.** — Light should be emitted at all angles in azimuth and up to at least 45° above the horizontal.

**1.5.3.3.3 The identification characters shall be transmitted in the International Morse Code.**

**1.5.3.3.4 RECOMMENDATION.** — The speed of transmission should be between six and eight words per minute, the corresponding range of duration of the Morse dots being from 0.2 to 0.15 second.

**CHAPTER 2. — LAND AERODROMES WITH RUNWAYS****2.1.—DAY MARKING AIDS****2.1.1 Approach day marking system.**

*Note.*—An approach day marking system consists of a configuration of day markers conforming to the specifications given in 2.1.1.2. Since structures supporting the lights of approach lighting systems have to be conspicuously marked (See 2.2.1.1.2.13), such structures may be utilized as part or all of an approach day marking system. Where the length of the row of approach light structures is insufficient to satisfy 2.1.1.2.2, paragraph 2.1.1.2.1 provides for additional markers in prolongation of the row of approach lights.

The decision as to whether day marking aids to approach are necessary at a particular aerodrome and, if so, whether they are needed at each end of every runway, or only in certain approach areas, is dependent upon local conditions. Consequently, it is for the Competent Authority to determine requirements for the provision of such aids. Recommendations made by ICAO Regional Air Navigation Meetings may afford guidance in determining requirements.

**2.1.1.1 RECOMMENDATION.** — *Application.* An approach day marking system should be provided when, in the opinion of the Competent Authority, it is difficult for pilots, under certain conditions, to make a satisfactory approach to the desired runway.

*Note.*—The conditions envisaged include lack of contrast between the runway and the surrounding terrain, featureless approach terrain or prevalence of poor visibility conditions due to smoke, haze, dust, etc., which may be associated with high background brightness.

**2.1.1.2 Characteristics.**

**2.1.1.2.1 RECOMMENDATION.** — The system should consist of a single row of markers spaced at uniform intervals, preferably of 60 metres (200 feet) but of not more than 90 metres

(300 feet) located in the approach area at the approach end of the runway served.

**2.1.1.2.2 RECOMMENDATION.** — The row of markers should extend from the runway threshold outwards for a distance of at least 900 metres (3,000 feet), except that where terrain conditions make this impracticable, the row should extend as far as conditions permit.

**2.1.1.2.3 RECOMMENDATION.** — The row of markers should be positioned either :

a) along the runway centre line extended, or

b) to the left of the approach and parallel to the extended centre line of the runway, provided that the row of markers is not placed more than 8 metres (25 feet) outwards from the edge of the runway.

**2.1.1.2.4 RECOMMENDATION.** — The positioning of approach day marking systems, in relation to the axes of the runways they serve, should be consistent at any one aerodrome.

**2.1.1.2.5 RECOMMENDATION.** — The system should be immediately identifiable as an approach system. The markers should be conspicuous and should contrast with their background. Their form should be such that they cannot be confused with runway markers.

*Note 1.*—Three dimensional objects provide greater contrast than do flat markers on the ground.

*Note 2.*—A specification covering the need for clearly identifiable runway threshold markings to be associated with approach day marking systems is included in 2.1.2.1.3.1.

2.1.1.2.6 RECOMMENDATION. — Each marker should be of sufficient size to provide an adequate signal.

Note.—If flat markers are used, minimum dimensions equivalent to 3 metres (10 feet) square will meet this requirement.

2.1.1.2.7 RECOMMENDATION. — The markers should not constitute obstructions.

2.1.1.2.8 RECOMMENDATION. — Where distance indication is considered desirable, suitable distance markers should be arranged at intervals of 300 metres (1,000 feet) starting from the runway threshold.

**2.1.2 Runway day markings (see Figure 28 in Attachment A).**

**2.1.2.1 Paved runways.**

2.1.2.1.1 RECOMMENDATION.—General. All runway markings should be of a conspicuous colour, preferably white.

**2.1.2.1.2 Runway caution zone markings.**

**2.1.2.1.2.1 Runway caution zone markings shall be displayed on instrument runways.**

Note.—Runway caution zone markings may be displayed on other runways.

2.1.2.1.2.2 Where provided, runway caution zone markings shall be of the form and dimensions shown in Figure 8. They shall be placed 1/3 of the runway length from each end of the runway.

**2.1.2.1.3 Runway threshold markings.**

2.1.2.1.3.1 RECOMMENDATION. — The threshold of an instrument runway or any runway with which an approach day marking system is associated should be so marked as to make it clearly identifiable and conspicuous under conditions of poor daylight visibility.

Note.—See Attachment B, section 9, for an appropriate method of marking.

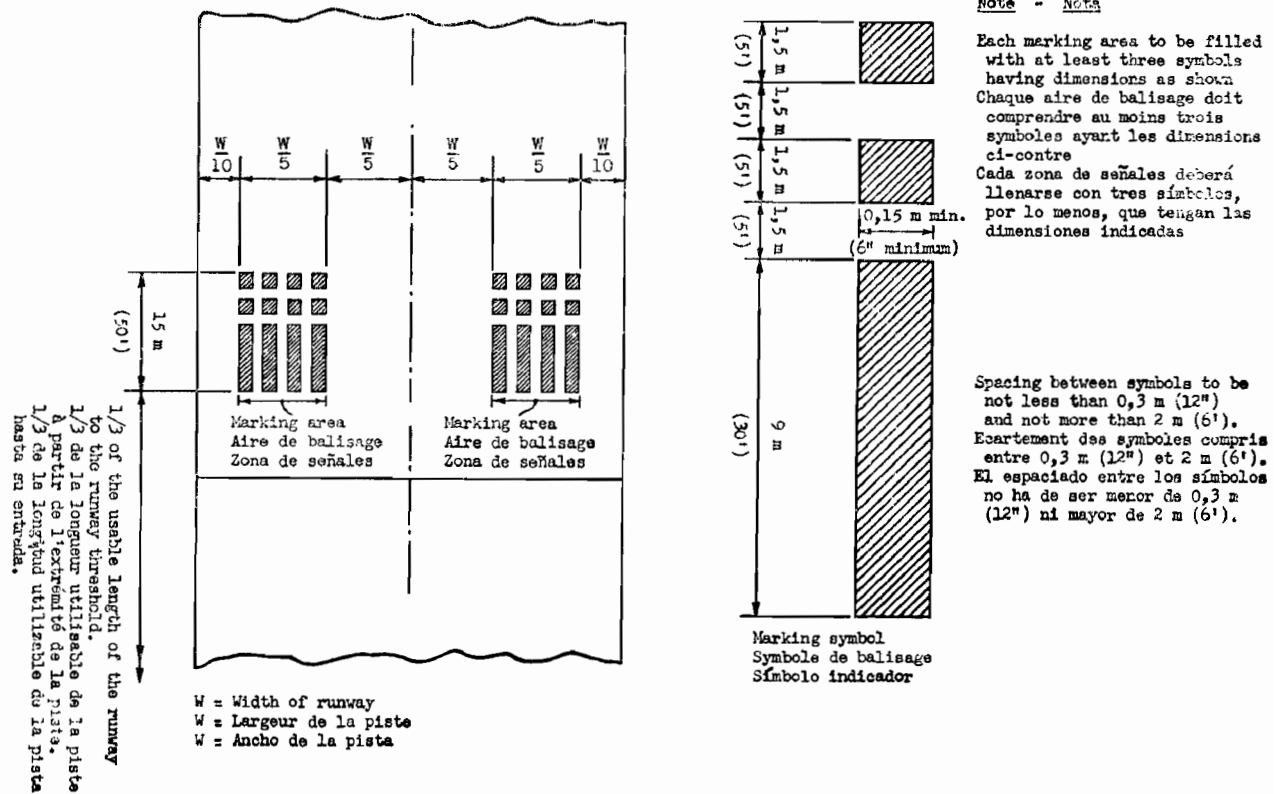

Figure 8. — Runway Caution Zone Markings

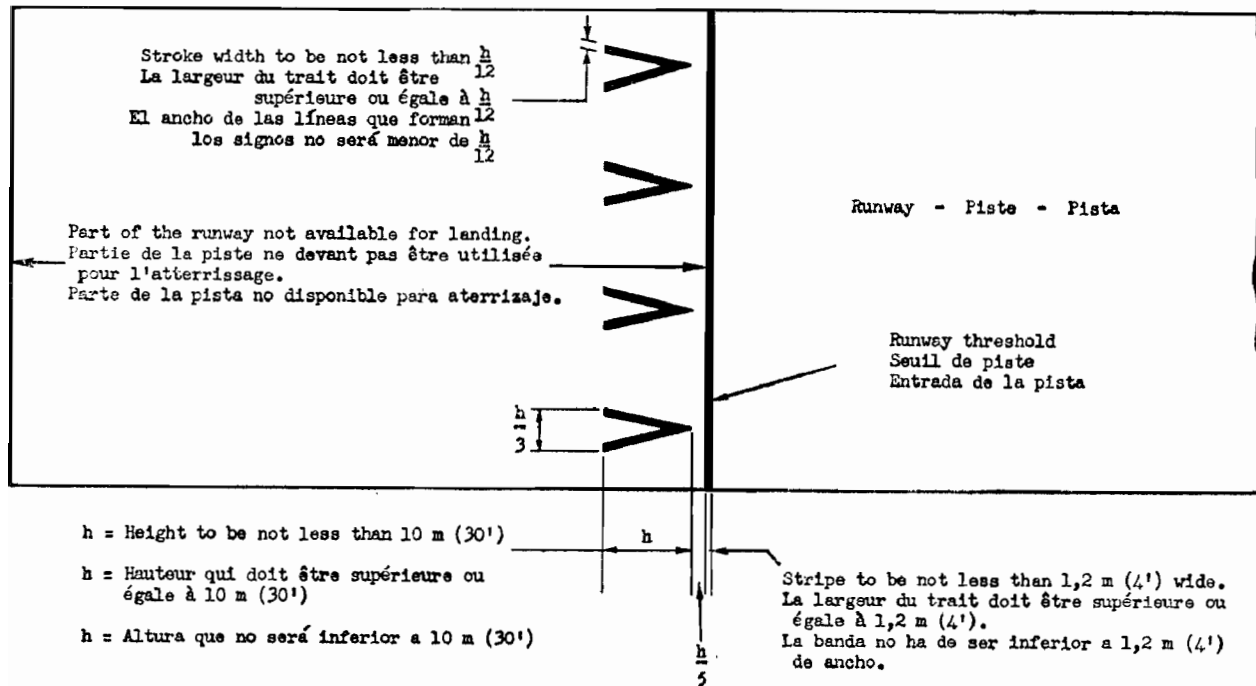

Figure 9. — Runway Threshold Markings

**2.1.2.1.3.2** Where a threshold has been removed from its normal position at the end of the runway, markings of the form and minimum dimensions shown in Figure 9 shall be used to indicate its altered position. Not less than four symbols shall be used equally spaced across the runway.

**2.1.2.1.4** *Runway designation markings.*

**2.1.2.1.4.1** *Assignment of numbers.* All runways shall be numbered with a two-digit number at each end. The number assigned shall be that whole number nearest to one-tenth of the magnetic azimuth of the centre line of the runway, measured clockwise from magnetic North when viewed from the direction of approach.

**2.1.2.1.4.2** *Assignment of letters.* A differentiating letter or letters shall be included in the runway designation of all

parallel runways at an aerodrome. The letter or letters assigned shall be as follows, in the order shown from left to right when viewed from the direction of approach.

For two parallel runways  
 "L" "R"

For three parallel runways  
 "L" "C" "R"

For four parallel runways  
 "L" "LC" "RC" "R"

For five parallel runways  
 "L" "LC" "C" "RC" "R"

**2.1.2.1.4.3** *Location.* The markings shall be placed at the most appropriate position near the end of the runway, in such a manner that the runway is effectively identified and shall conform to the arrangement shown in Figure 10.



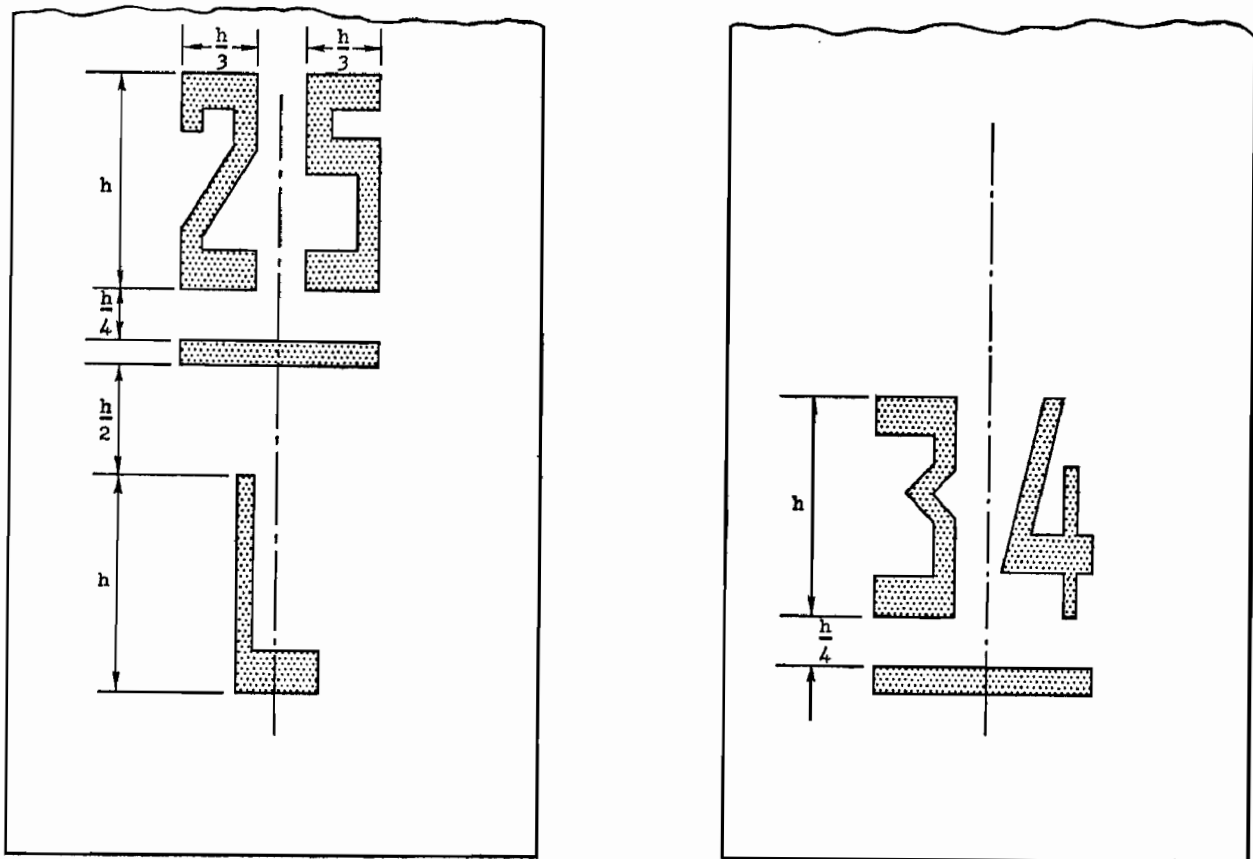

h = Height of numbers and letters (see Fig. 11)  
 h = Hauteur des chiffres et des lettres (voir Fig. 11)  
 h = Altura de los números y letras (véase Fig. 11)

Fractions of "h" are approximative  
 Les fractions de "h" sont approximatives  
 Las fracciones de "h" son aproximadas

Figure 10. — Runway Designation Markings

**2.1.2.1.4.4 Characteristics.** The numbers and letters shall be of the form and proportions shown in Figure 11. The dimensions shall be not less than those shown in Figure 11.

**2.1.2.1.5 Runway longitudinal markings.**

**2.1.2.1.5.1** RECOMMENDATION. — Runway longitudinal markings should be displayed on all runways.

**2.1.2.1.5.2** Where provided, runway longitudinal markings shall extend along the whole length of runways between the two runway designation markings except that longitudinal markings on runways other than instrument runways may be interrupted at runway intersections.

**2.1.2.1.5.3** RECOMMENDATION. — Runway longitudinal markings should be as shown either in Figure 12 or in Figure 13.

**2.1.2.2 Unpaved runways.**

**2.1.2.2.1** RECOMMENDATION.—*General.* Unpaved runways should be provided, so far as practicable, with the markings prescribed for paved runways in 2.1.2.1.

**2.1.2.2.2 Runway edge markings.**

**2.1.2.2.2.1** RECOMMENDATION. — Where the extent of a runway is not clearly indicated by the appearance of its surface compared with that of the surrounding ground, simple day markers should be provided for this purpose. Where runway and threshold lights are provided, the markers should be incorporated in the light fixtures.

Where there are no lights, day markers of flat rectangular or conical shape should be placed so as to delimit clearly the runway.

2.1.2.2.2.2 RECOMMENDATION.—The flat rectangular markers should have a minimum size of 1 metre (3 feet) by 3 metres (10 feet) and should be placed with their long dimension parallel to the runway centre line. The conical

markers should have a height not exceeding 0.5 metre (20 inches).

2.1.2.3 Marking of snow-covered runways.

2.1.2.3.1 RECOMMENDATION.—General. Markers should be used to indicate the usable limits of snow-covered runways.

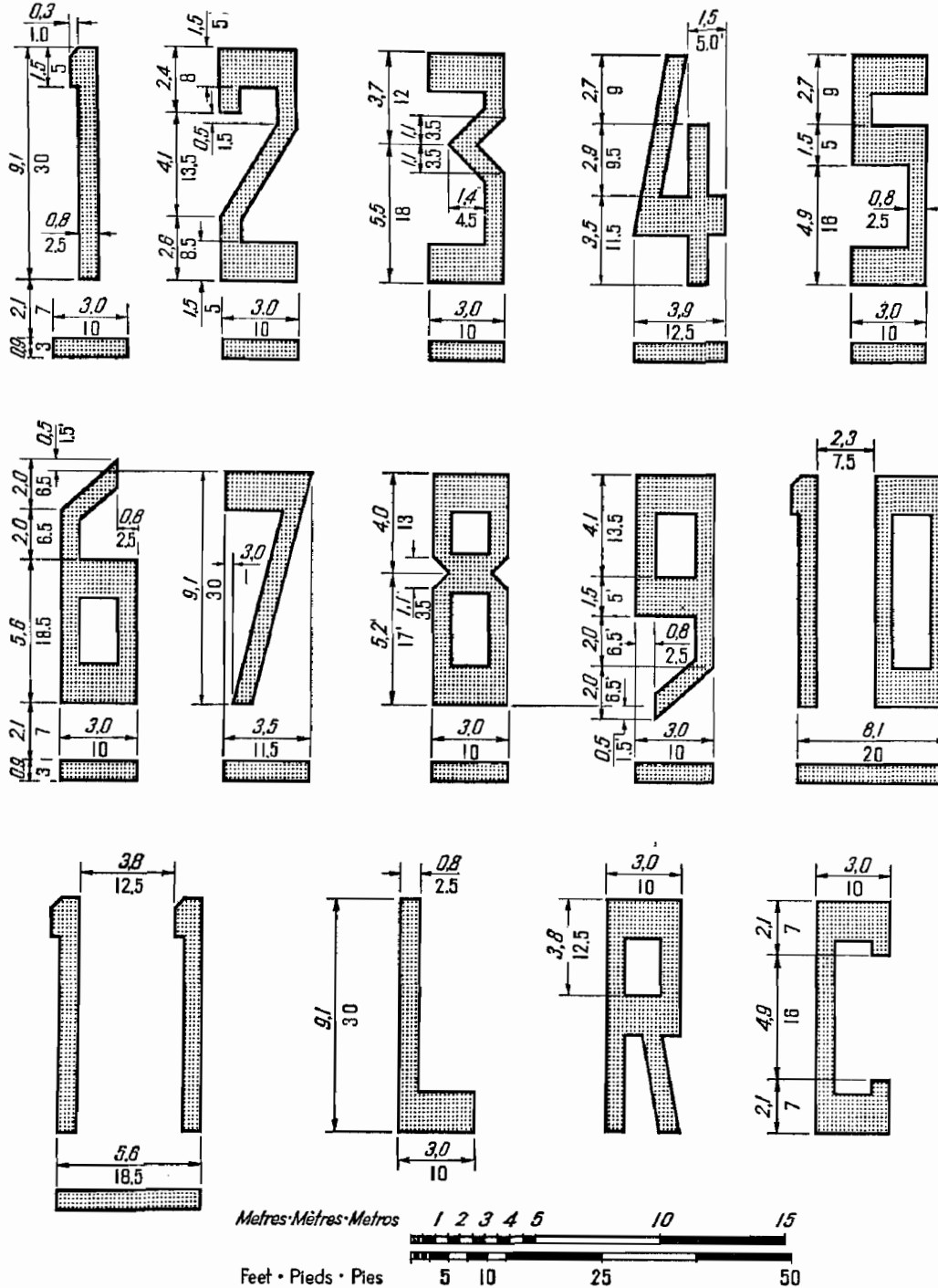

Two figures are given for each dimension; the upper (slanting) figure represents metres, the lower (vertical) figure represents feet.

Figure 11. — Form and Proportions of Numbers and Letters for Runway Designation Markings

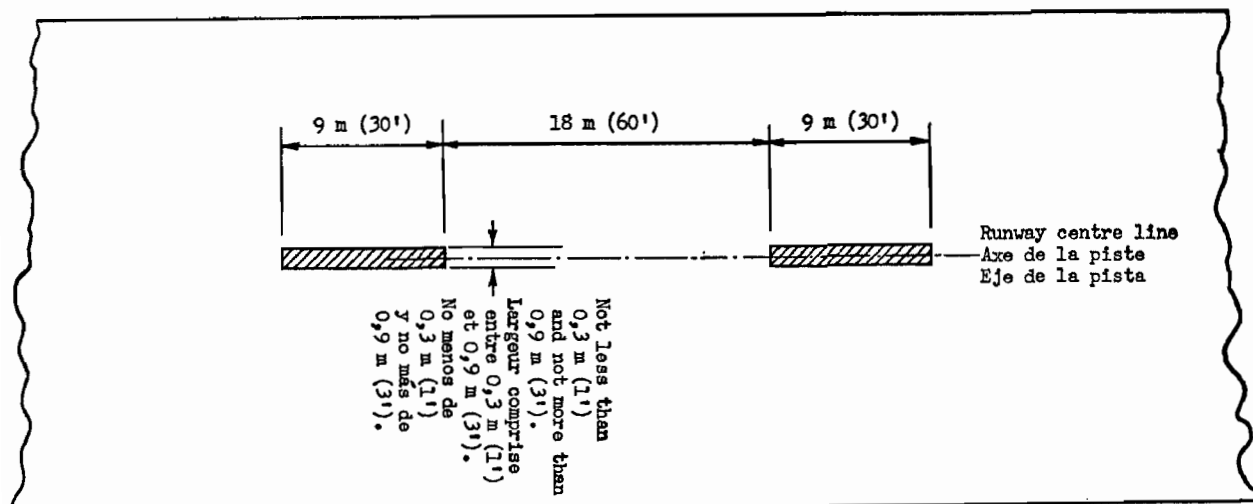

Figure 12. — Longitudinal Runway Markings

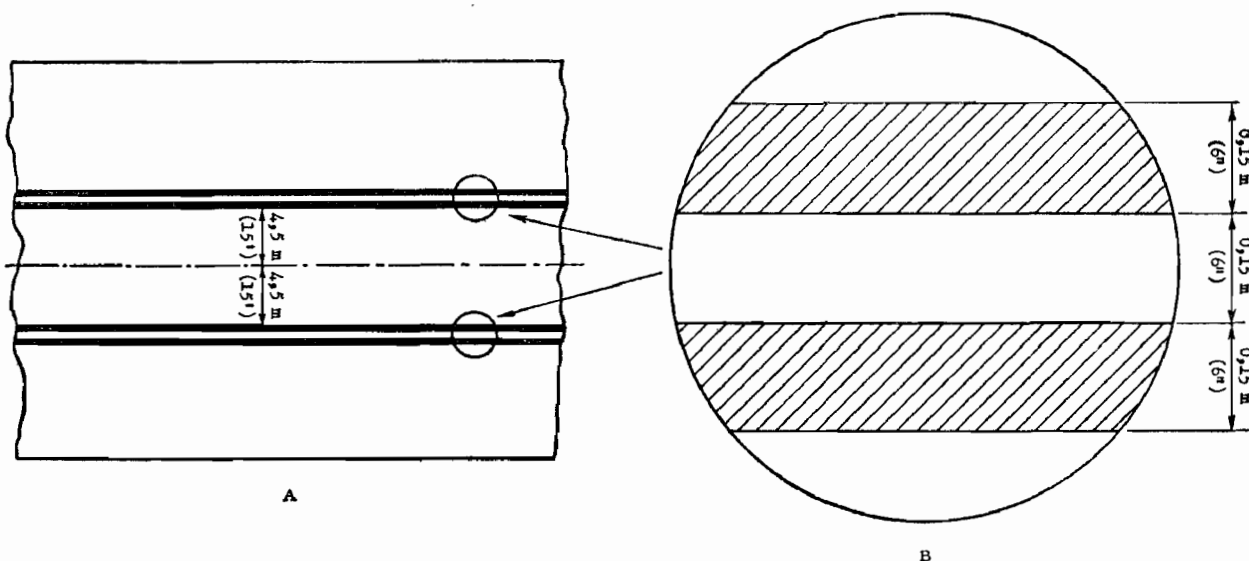

Figure 13. — Longitudinal Runway Markings

2.1.2.3.2 **RECOMMENDATION.** — *Location.* Markers should be placed along the sides of the snow-covered runways, spaced at intervals of not more than 100 metres (330 feet) and should be located symmetrically about the axis of the runway. Sufficient markers should be placed across the end of the runway to indicate the threshold.

2.1.2.3.3 **RECOMMENDATION.** — *Characteristics.* Markers on snow-covered runways should consist of conspicuous objects such as spruce trees about 1.5 metres (5 feet) high, set upright, or light wooden tripods. (See Figure 29 in Attachment A.)

### 2.1.3 **Taxiway day markings.** (See Figure 28 in Attachment A).

#### 2.1.3.1 **Paved taxiways.**

2.1.3.1.1 **RECOMMENDATION.** — *Application.* Longitudinal markings should be displayed on all paved taxiways and taxi holding position markings should be displayed at all intersections of paved taxiways with runways.

2.1.3.1.2 **Location.** Where provided, the location shall be as shown in Figures 14 or 15.

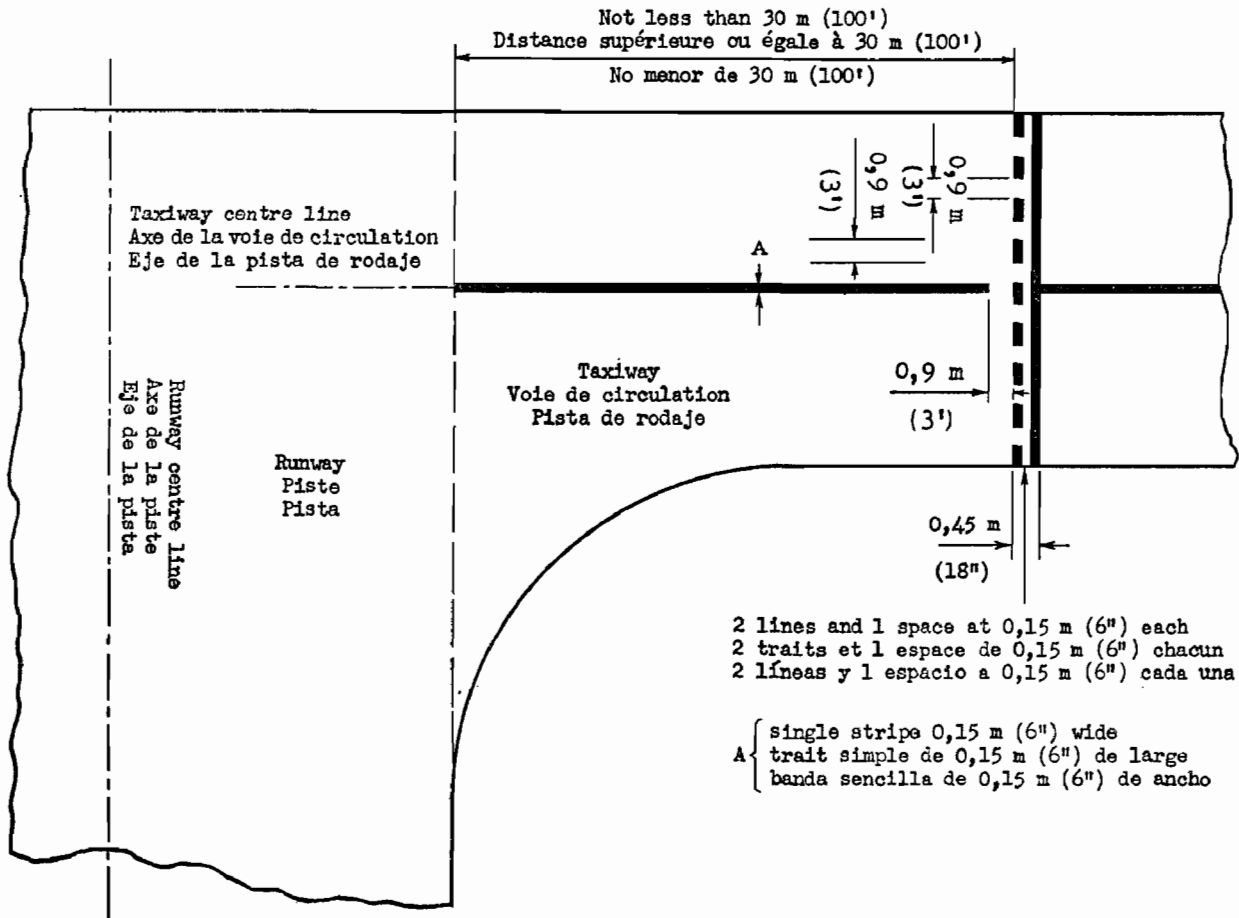

Figure 14.—Taxi Longitudinal and Holding Position Markings

### 2.1.3.1.3 Characteristics.

2.1.3.1.3.1 RECOMMENDATION. — *Colour.*  
The markings should be of a conspicuous colour, preferably white or yellow.

2.1.3.1.3.2 *Longitudinal markings.*  
Where provided, the longitudinal markings shall be as shown in Figure 14.

2.1.3.1.3.3 *Taxi holding position markings.* Where provided, the taxi holding position markings shall be as shown either in Figure 14 or in Figure 15.

*Note.*—Particularly on taxiways serving instrument runways the markings shown in Figure 15 may be found preferable.

2.1.3.2 RECOMMENDATION. — *Unpaved taxiways.* Unpaved taxiways should be provided, so far as practicable, with the markings prescribed for paved taxiways in 2.1.3.1.

2.1.3.2.1 RECOMMENDATION. — Where the extent of a taxiway is not clearly indicated by the appearance of its surface as compared with that of the surrounding ground, simple day markers should be provided for this purpose. Where taxiway lights are provided, the markers should be incorporated in the light fixtures. Where there are no lights, day markers of conical shape should be placed so as to delimit clearly the taxiway.

2.1.3.2.2 RECOMMENDATION. — The conical markers should have a height not exceeding 0.5 metre (20 inches) and should be of such colour as to contrast with the background and be readily distinguishable from runway markers.

## 2.2.—LIGHTING AIDS

### 2.2.1 Approach lighting systems.

When the following term is used in this Annex, it has the following meaning:

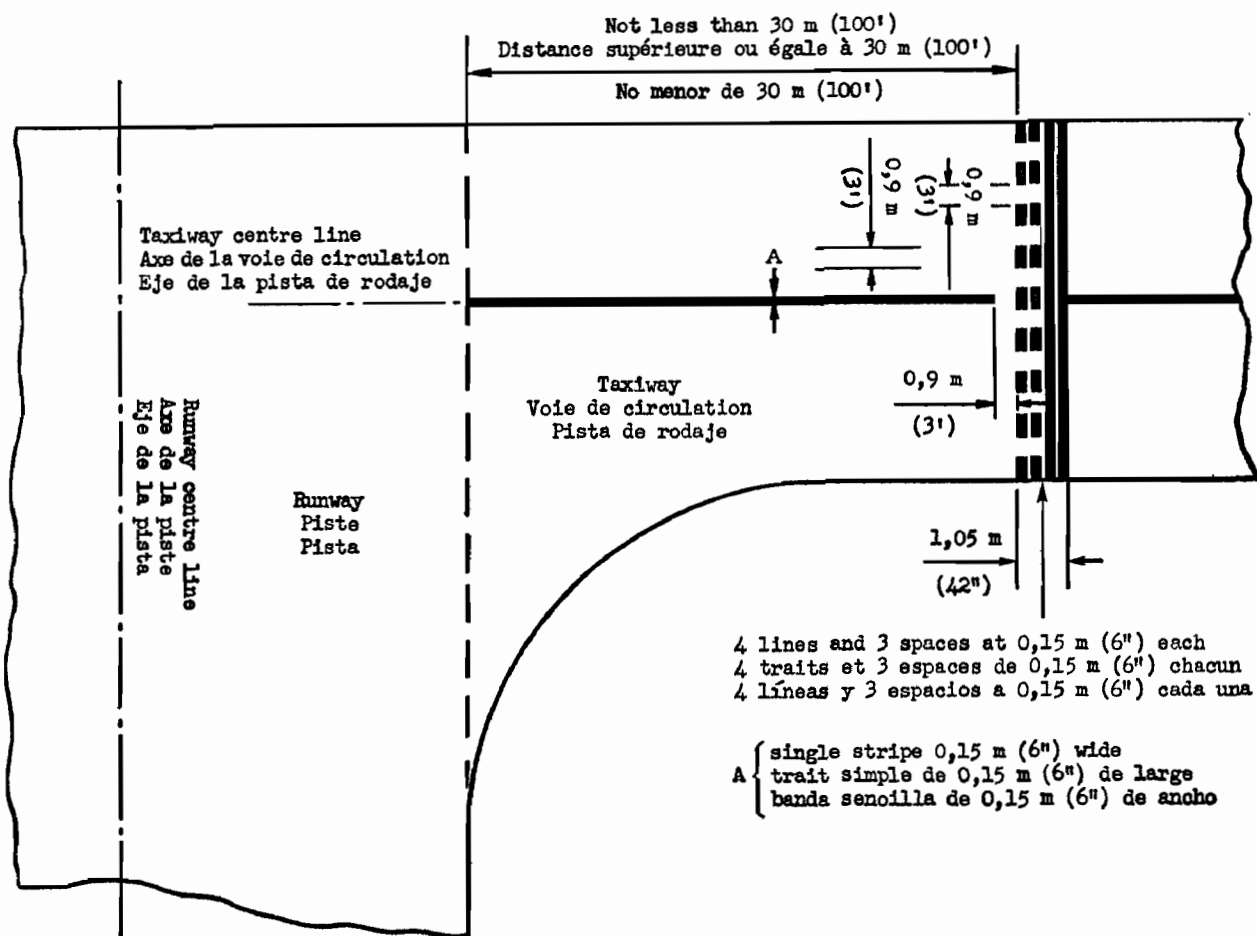

Figure 15. — Taxi Longitudinal and Holding Position Markings

**Approach portal.** An area, lying in the vertical plane perpendicular to the runway axis and 1,050 metres (3,500 feet) from the threshold, through which an aircraft making an instrument approach may be expected to pass.

*Note.*—For the purposes of this Annex, approach lighting systems have been divided into two types: type A and type B.

Type A has been known popularly as a simple system, a low intensity system or a lead-in system. Type B has been known as an elaborate system, a complete system, a high intensity system or a let-down system. All of these terms are descriptive to some extent but are not sufficiently precise to be adopted for use in the Annex. It is for this reason that the terms "approach lighting system type A" and "approach lighting system type B" have been used.

Approach lighting system type A is a simple system of lights designed with the intention of affording guidance to pilots approaching to land when the ground plane is visible and the atmospheric transmission is equal to or greater than that represented by a daylight object visibility of 800 metres (2,650 feet or ½ mile). It is intended for use at aerodromes where topographical, meteorological, operational or traffic conditions introduce factors

that make the provision of an approach lighting system type B unwarranted.

Approach lighting system type B is a system designed to permit approaches in weather conditions inferior to those for which approach lighting system type A is designed, irrespective of whether or not the ground plane is visible.

While the AGA Division made recommendations for three different configurations for approach lighting system type B, Council was not able to accept these recommendations for inclusion in the Annex. Descriptions of the three configurations and their design features are contained in the final report of the Fourth Session of the AGA Division, Doc 6932-AGA/590.

### 2.2.1.1 Approach lighting system type A.

#### 2.2.1.1.1 Application.

2.2.1.1.1.1 An approach lighting system type A shall be installed for use in connection with each instrument runway, irrespective of the type of non-visual aid provided, except where an approach lighting system type B is installed.

2.2.1.1.1.2 RECOMMENDATION.—The system should be installed for use in connection with runways other than instrument runways as may be deemed necessary.

#### 2.2.1.1.2 Characteristics.

2.2.1.1.2.1 The system shall consist of a single row of fixed lights spaced at intervals of not more than 90 metres (300 feet) located in the approach area at the approach end of the runway served.

*Note.*—Flashing lights may be added to improve identification.

2.2.1.1.2.2 RECOMMENDATION. — The spacing of the lights should, as far as practicable, be uniform.

2.2.1.1.2.3 The row of lights shall extend from the runway threshold outwards for a distance of not less than 450 metres (1,500 feet).

2.2.1.1.2.4 RECOMMENDATION. — Normally the row of lights should extend from the runway threshold outwards for a distance of 900 metres (3,000 feet).

2.2.1.1.2.5 The row of lights shall be positioned either:

*a)* along the runway centre line extended, or

*b)* to the left of the approach and parallel to the extended centre line of the runway, provided that the row of lights is not placed more than 8 metres (25 feet) outwards from the left-hand edge of the runway.

2.2.1.1.2.6 RECOMMENDATION. — The positioning of approach lighting systems, in relation of the axes of the runways they serve, should be consistent at any one aerodrome.

2.2.1.1.2.7 The intensity of the lights shall be such that:

*i)* by night — all the lights, and

*ii)* by day — at least three lights

are visible from any point in the approach portal when the ground plane is visible and the atmospheric transmission is equal to or greater than that represented by a daylight

object visibility of 800 metres (2,650 feet or ½ mile).

2.2.1.1.2.8 The maximum intensity of each light shall be directed towards the approach portal.

*Note 1.*—Uniform intensity distribution of each light throughout the solid angle subtended at the light by the approach portal will help to ensure that the lights are visible from approaching aircraft.

*Note 2.*—The provision of lights visible through 360 degrees in azimuth will enable the system to be used for circling approaches in visibility conditions superior to those for which the system is mainly designed.

2.2.1.1.2.9 The lights that form the row shall produce no dazzle disconcerting to a pilot approaching to land.

2.2.1.1.2.10 The characteristics of the system of lights shall be such as to ensure that it is readily distinguishable from:

*i)* other aeronautical ground lights; and

*ii)* extraneous lighting, if present.

*Note.*—Action to be taken to avoid the existence of “confusing lights” in the vicinity of aeronautical lighting aids is recommended in 1.1.2.

2.2.1.1.2.11 RECOMMENDATION. — As far as practicable, neither the lights nor the structures supporting them should project above the approach surface.

*Note.*—In particular cases where it is impracticable to keep the lights or supporting structures below the approach surface, it is a matter for the Competent Authority to weigh the advantages likely to be gained from the information provided by an approach lighting system against the hazard created.

2.2.1.1.2.12 There shall be an unobstructed line of sight between any light in the row and all points in the approach portal.

2.2.1.1.2.13 Structures supporting the lights shall be conspicuously marked to provide guidance to aircraft approaching to land by day.

*Note.*—The fact that properly marked approach light supporting structures may form part of an approach day marking system is referred to in the Note to 2.1.1.

#### 2.2.1.2 Angle-of-approach lights.

*Note.*—It may be useful to install an angle-of-approach light to indicate an appropriate glide path.

### 2.2.1.2.1 *Location.*

**2.2.1.2.1.1** When used, angle-of-approach lights shall be placed outside but close to the edge of the runway. If one angle-of-approach light only is provided, it shall be installed on the left-hand side of the runway as viewed from an aircraft approaching to land.

**2.2.1.2.1.2** RECOMMENDATION. — The longitudinal location of the angle-of-approach lights should be:

*i*) at a point between 60 metres (200 feet) and 90 metres (300 feet) measured inwards from the runway threshold, if not intended for simultaneous use with an electronic approach aid, or

*ii*) at a point which will ensure that the lower edge of the green beam will coincide with the glide path as defined by the electronic aid, if intended for simultaneous use with an electronic approach aid.

### 2.2.1.2.2 *Characteristics.*

**2.2.1.2.2.1** The angle-of-approach light shall produce three contiguous beams of coloured light with a sharp change of colour at the boundaries between beams. The lowest beam shall be red with a spread in the vertical plane of not less than 3 degrees. The middle beam shall be green with a spread in the vertical plane of 2 degrees. The upper beam shall be yellow with a spread in the vertical plane of not less than 6 degrees. The spread of any beam in the horizontal plane shall be not less than 12 degrees and the centre of the beam shall be so orientated in azimuth as to provide the best possible guidance for a pilot approaching to land. The intensity of the light within the angles specified above shall not be less than 200 candles for any colour. The light shall emit flashes of equal duration, at a frequency of 30 to 60 per minute, the duration of the flashes being longer than the intervening dark periods.

**2.2.1.2.2.2** RECOMMENDATION. — In the case of angle-of-approach lights intended for use with an electronic approach aid, the lower edge of the green beam should coincide with the glide path of the electronic approach aid. In the case of angle-of-approach lights not intended for use

with an electronic approach aid, the angle of elevation of the centre of the green beam should be between the limits of 3½ degrees and 4½ degrees above the horizontal. If two angle-of-approach lights are used, the elevation of the green beams should be the same. At all times, however, the low limit of the green beam should provide guidance giving adequate clearance above all obstructions on the approach path.

## 2.2.2 *Runway lighting.*

### 2.2.2.1 *Runway lights.*

**2.2.2.1.1** *Application.* Runway lights shall be provided on all runways intended for use at night.

### 2.2.2.1.2 *Location.*

**2.2.2.1.2.1** Runway lights shall be placed along the full length of the runway, between the threshold lights, and shall be in two straight lines parallel to and equidistant from the centre line.

### 2.2.2.1.2.2 RECOMMENDATION.

*a*) Where the width of the rectangular area intended for use as a runway is 45 metres (150 feet) or less, the lines should either be placed along the edges of the area or outside the edges a distance of not more than 4.5 metres (15 feet).

*b*) Where the width of the rectangular area exceeds 45 metres (150 feet) the distance between the rows of lights should not be less than 45 metres (150 feet) and should not be greater than the width of the rectangular area plus 4.5 metres (15 feet) on either side.

*Note.*—In the case of instrument runways it is preferable not to exceed a spacing of 70 metres (230 feet) between the rows of lights.

*c*) The lights should be uniformly spaced in rows at intervals of not more than 60 metres (200 feet) for instrument runways and at intervals of not more than 100 metres (330 feet) for all other runways. The lights on opposite sides of the runway axis should be on lines at right angles to that axis. At intersections of runways, lights may be spaced irregularly or omitted.

### 2.2.2.1.3 *Characteristics.*

2.2.2.1.3.1 Runway lights shall be fixed lights showing variable-white, except that on an instrument runway the lights, as seen from either end, shall show variable-yellow for a section at the remote end of the runway. This section shall extend from the end of the runway to and including the runway light nearest to a point one-third of the length of the runway from that end.

#### 2.2.2.1.3.2 RECOMMENDATION.

a) The lights should show at all angles in azimuth and up to at least 30 degrees above the horizontal. The intensity of the white light should be not less than 50 candles in all directions from which a final approach is likely to be made.

b) In addition to the above, the lights on instrument runways should have an intensity and a light distribution such that, when installed at the spacing for which they are designed, an adequate indication is given under all visibility conditions in which it is intended that landings will be made by the aid of the lights.

### 2.2.2.2 *Runway threshold lights.*

2.2.2.2.1 *Application.* Runway threshold lights shall be provided on all runways equipped with runway lights.

#### 2.2.2.2.2 *Location.*

2.2.2.2.2.1 Runway threshold lights shall be placed in a line on each runway threshold, the line being at right angles to the runway axis and the lights indicating the limits of the surface usable for landing. The lights shall be equally spaced between the lines of runway lights or arranged in groups near the lines of runway lights. The number of lights on any runway threshold shall be at least four with one light in line with each line of runway lights. The lights shall be arranged to show simultaneously at both ends of the runway.

2.2.2.2.2.2 When the threshold has been altered as in cases where a section at the end of the runway is either completely unusable or only partially usable because of

obstructions in the approach, the altered threshold shall be indicated by threshold lights located as required in 2.2.2.2.2.1. In such cases the original runway lights and threshold lights outlining the end section shall be obscured if the section is completely unusable or replaced by blue lights if the section is usable for movement of aircraft.

### 2.2.2.2.3 *Characteristics.*

2.2.2.2.3.1 Runway threshold lights shall be fixed lights showing green at all angles in azimuth and up to at least 30 degrees above the horizontal.

2.2.2.2.3.2 RECOMMENDATION. — The intensity of the coloured lights should be at least 15 per cent of the intensity of the white runway lights when measured in corresponding directions.

*Note.*—An intensity comparable with the runway lights is considered desirable provided dazzle is not introduced.

2.2.2.2.3.3 RECOMMENDATION. — Threshold lights at the end of an instrument runway where a system of approach lights is installed should, in addition to providing the omni-directional characteristics prescribed in 2.2.2.2.3.1, have beam characteristics and an intensity comparable with the approach lights with which they are associated.

### 2.2.3 *Taxiway lighting.*

2.2.3.1 RECOMMENDATION.—*Application.* Taxiway lights should be provided on all taxiways required for use at night, except where the traffic is so infrequent that it can be satisfactorily guided by other means.

#### 2.2.3.2 *Location.*

2.2.3.2.1 Where provided, the lights shall be so arranged as to provide a clear and continuous indication of any taxiing route to be followed. The lights shall be placed either along both sides of the taxiway or along the centre line, or both along the sides and the centre line.

*Note.*—At aerodromes with complicated taxiway intersections where centre line taxiway lighting is provided, it may be necessary to add edge lighting.



2.2.3.2.2 **RECOMMENDATION.** — When placed along the sides, the lights should be as near the edges of the taxiways as practicable and not more than 3 metres (10 feet) outside.

2.2.3.2.3 **RECOMMENDATION.** — The spacing between lights in any straight line should not exceed 60 metres (200 feet). The spacing between lights on curves should be less so that a clear indication of the curve is provided.

2.2.3.3 **Characteristics.** Where taxiway lights are provided, the following specifications apply:

2.2.3.3.1 **Taxiway lights shall be fixed lights. Light shall be emitted through all necessary angles in azimuth and up to at least 30 degrees above the horizontal.**

2.2.3.3.2 **When lights are placed along the sides of the taxiway, they shall be**

**either blue on both sides or blue on one side and yellow on the other.**

2.2.3.3.3 **RECOMMENDATION.** — Yellow light distribution, however, should be such that the yellow light is visible only to aircraft on or in the immediate vicinity of the taxiway.

2.2.3.3.4 **When lights are placed on the centre line of the taxiway, they shall be green.**

2.2.3.3.5 **RECOMMENDATION.** — The green light distribution should be such that the green light is visible only to aircraft on or in the immediate vicinity of the taxiway.

*Note.*—Care is necessary to limit the light distribution of green taxiway lights near runways so as to avoid possible confusion with threshold lights.

## CHAPTER 3. — WATER AERODROMES

*Note.*—This Chapter deals with visual ground aids for water aerodromes including those with and without channels.

It is considered important that water aerodrome lighting, apart from obstruction and taxi-channel lighting, should be clearly and easily distinguishable from land aerodrome lighting in order to avoid the possibility of a landplane being inadvertently landed on a water aerodrome or vice versa. The colour characteristics of lights for water aerodromes have been selected on this principle rather than with a view to providing for maximum light intensities. This is deemed reasonable since the density of traffic at water aerodromes, both at the present time and in the foreseeable future is not likely to warrant the provision of visual aids in excess of those that will enable seaplanes to be operated safely in fair weather conditions. There is, however, nothing to prevent the Competent Authority from installing, at a particular site, additional visual aids, i.e. an approach lighting system, angle-of-approach lights, etc., providing such aids do not conflict with the aids set down in this Chapter.

If it is found necessary in the future to provide for operations under low visibility conditions or for any considerable increase in the density of traffic at water aerodromes, it may be necessary to reconsider the visual ground aid requirements for water aerodromes, in particular the colour characteristics for light aids to landing.

Although every endeavour has been made to avoid the possibility of conflict with marine signals, in the case of water aerodromes situated at or in the vicinity of navigable waters on which marine navigation is

practised, it will rest with the Competent Authority to decide, in conjunction with the maritime authorities, to what extent these Standards and Recommended Practices can be applied without danger of conflict or confusion.

In the case of landing aids, three types of lighting are set forth. The selection of the type to be adopted for a particular aerodrome is left to the Competent Authority to make, taking into consideration the recommendations of ICAO Regional Air Navigation Meetings as accepted by Council and all other relevant factors, such as the needs of marine navigation, etc.

### 3.1.—AIDS TO LANDING

#### 3.1.1 Day marking.

##### 3.1.1.1 Application.

3.1.1.1.1 **Where water aerodrome lighting is provided, each light support shall be conspicuously marked.**

*Note.*—Where the size of the support provides sufficient area for the marking, no additional structure is necessary.

3.1.1.1.2 **RECOMMENDATION.** — Channels used only by day and so not provided with lighting should be clearly defined by day marking.

*Note.*—Day marking may also be required at water aerodromes such as lakes, bays, etc., used only by day, if the limits of the landing area are not clearly indicated by natural features.

### 3.1.1.2 Characteristics.

3.1.1.2.1 RECOMMENDATION. — Where provided, the markers should present an area of approximately 0.4 square metre (4 square feet) when viewed from any angle in azimuth and up to at least 30 degrees above the horizontal.

3.1.1.2.2 RECOMMENDATION. — The markers should be conspicuously coloured, with alternate vertical stripes of yellow and black, not less than 0.15 metre (6 inches) in width.

### 3.1.2 Lighting.

#### 3.1.2.1 General.

3.1.2.1.1 *Double row lighting* is a type of water aerodrome lighting consisting of two lines of channel lights and associated threshold lights.

3.1.2.1.2 *Single row lighting* is a type of water aerodrome lighting consisting of one line of lights and associated threshold lights.

3.1.2.1.3 *Boundary lighting* is a type of water aerodrome lighting consisting of boundary lights and range lights.

#### 3.1.2.2 Application.

3.1.2.2.1 Water aerodromes intended for use during hours of darkness shall be equipped with one or more of the three types of lighting as defined in 3.1.2.1.

3.1.2.2.2 RECOMMENDATION. — Water aerodromes with channels physically limited to 300 metres (1,000 feet) width or less and intended for use during hours of darkness should be equipped with double row lighting.

3.1.2.3 *Double row lighting.* When double row lighting is provided, the following specifications apply:

#### 3.1.2.3.1 Channel lights.

##### 3.1.2.3.1.1 Location. The channel

lights shall be placed in straight lines along the sides of the channels.

3.1.2.3.1.2 RECOMMENDATION. — The lines of lights should be not more than 300 metres (1,000 feet) apart.

3.1.2.3.1.3 RECOMMENDATION. — The lights in each row should be uniformly spaced at intervals of not more than 150 metres (500 feet), the first and last lights being not more than 150 metres (500 feet) from the ends of the channel. As far as possible, the lights on opposite sides of the channel axis should be on lines at right angles to that axis.

3.1.2.3.1.4 *Characteristics.* Channel lights shall be fixed lights showing green at all angles in azimuth and up to at least 30 degrees above the horizontal. The intensity of the lights shall be not less than 10 candles of green light.

#### 3.1.2.3.2 Threshold lights.

3.1.2.3.2.1 *Location.* Threshold lights shall be placed on each channel threshold in a straight line at right angles to the channel axis.

3.1.2.3.2.2 RECOMMENDATION. — Where the width of the channel does not exceed 150 metres (500 feet), four lights should be provided at each end of the channel. The lights should be arranged in groups of two with one group at each end of each row of channel lights.

3.1.2.3.2.3 RECOMMENDATION. — Where the width of the channel is more than 150 metres (500 feet), additional lights should be provided between the two groups of two lights at each end of the channel at spacings of not less than 60 metres (200 feet) and not more than 100 metres (330 feet).

3.1.2.3.2.4 *Characteristics.* Threshold lights shall be fixed lights showing yellow at all angles in azimuth and up to at least 30 degrees above the horizontal. The intensity of the lights shall be not less than 10 candles of yellow light.

3.1.2.4 *Single row lighting.* Where single row lighting is provided, the following specifications apply:

### 3.1.2.4.1 *Line of lights.*

**3.1.2.4.1.1 *Location.*** The lights shall be placed in a straight line along the left side of the landing path as viewed from the approach.

**3.1.2.4.1.2 RECOMMENDATION.** — The lights should be uniformly spaced at intervals of not more than 300 metres (1,000 feet). The lights should be at least eight in number, not including the threshold lights placed at each end of the line.

**3.1.2.4.1.3 *Characteristics.*** The lights shall be fixed lights showing green at all angles in azimuth and up to at least 30 degrees above the horizontal. The intensity of the lights shall be not less than 10 candles of green light.

### 3.1.2.4.2 *Threshold lights.*

**3.1.2.4.2.1 *Location.*** One threshold light shall be placed at each end of the line of lights in line with it and at a distance from the nearest green light equal to the interval between successive green lights.

**3.1.2.4.2.2 RECOMMENDATION.** — An additional threshold light should be placed at not less than 150 metres (500 feet) and not more than 300 metres (1,000 feet) to the right, as viewed from the approach, of each of the threshold lights mentioned in 3.1.2.4.2.1. The four lights should thus form the corners of a rectangle.

**3.1.2.4.2.3 RECOMMENDATION.** — Where other additional lights are provided, they should be placed at each end of the landing area. These lights should be spaced at intervals of 100 metres (330 feet) or less to the right of the lights mentioned in 3.1.2.4.2.2 and to the left of the lights mentioned in 3.1.2.4.2.1 provided that the additional lights installed on the right side, as viewed from the approach, should only be used if the rectangular area defined thereby is a usable area.

**3.1.2.4.2.4 *Characteristics.*** Threshold lights shall be fixed lights showing yellow at all angles in azimuth and up to at least 30 degrees above the horizontal. The intensity of the lights shall be not less than 10 candles of yellow light.

**3.1.2.5 *Boundary lighting.*** Where boundary lighting is provided, the following specifications apply:

### 3.1.2.5.1 *Boundary lights.*

**3.1.2.5.1.1 RECOMMENDATION.** — *Location.* Boundary lights should be placed along the boundary of the landing area at intervals of approximately 150 metres (500 feet).

**3.1.2.5.1.2 *Characteristics.*** Boundary lights shall be fixed lights showing green at all angles in azimuth and up to at least 30 degrees above the horizontal. The intensity of the lights shall be not less than 10 candles of green light.

### 3.1.2.5.2 *Range lights.*

**3.1.2.5.2.1 *Location.*** Range lights shall form part of the boundary lighting system and be placed in straight lines at right angles to preferred landing paths.

**3.1.2.5.2.2** Range lights placed at each end of a preferred landing path shall consist of groups of equal numbers of lights arranged symmetrically about the axis of the preferred landing path. The groups used on each path shall contain a number of lights different from that used to indicate any other path. The landing path prescribed for use under conditions of light winds (less than 5 knots) or, in the absence of such prescription, the longest landing path shall have the greatest number of lights. The lights in a group shall be arranged at equal intervals of not more than 30 metres (100 feet).

**3.1.2.5.2.3 *Characteristics.*** Range lights shall be fixed lights showing yellow at all angles in azimuth and up to at least 30 degrees above the horizontal. The intensity of the lights shall be not less than 10 candles of yellow light.

## 3.2.—AIDS TO TAXYING

**3.2.1 *Day marking.*** Where taxi channel lighting is provided, each light support shall be conspicuously marked.

### 3.2.2 *Lighting.*

*Note.*—Taxi-channel lighting may be provided on channels that are outside the landing area and that are not provided with marine lighting.

**3.2.2.1 Characteristics.** Where provided, taxi-channel lights shall be fixed lights showing blue. The light shall be emitted

through all necessary angles in azimuth and up to at least 30 degrees above the horizontal.

## CHAPTER 4. — LAND AERODROMES WITHOUT RUNWAYS

### 4.1.—DAY MARKING AIDS

#### 4.1.1 Boundary marking.

**4.1.1.1 RECOMMENDATION.—Application.** Boundary markers should be provided at land aerodromes without runways.

#### 4.1.1.2 Location.

**4.1.1.2.1 Boundary markers shall be placed along the boundary of the landing area and at such corners as may be necessary for marking clearly the limits of the landing area.**

**4.1.1.2.2 RECOMMENDATION.** — The markers should be spaced at intervals of not more than 200 metres (600 feet) if the type shown in Figure 16 is used, or approximately 90 metres (300 feet) if the conical type is used.

**4.1.1.3 RECOMMENDATION.** — *Characteristics.* Boundary markers should be of a form similar to that shown in Figure 16 or in the form of a cone not less than 0.50 metre (20 inches) high and not less than 0.75 metre (30 inches) in diameter. The markers should be a single conspicuous colour, preferably orange, or two contrasting colours, preferably orange and white.

### 4.2.—LIGHTING AIDS

#### 4.2.1 Boundary lights.

**4.2.1.1 RECOMMENDATION.—Application.** Boundary lights should be provided at each land aerodrome without runways intended for use at night.

**4.2.1.2 Location.** Where provided, boundary lights shall be arranged at intervals of not more than 100 metres (330 feet) along the boundary of the landing area except that boundary lights may be omitted in

building areas where the outline of the landing area is adequately indicated by apron floodlighting or similar illumination.

*Note.—A somewhat reduced spacing is generally considered desirable.*

**4.2.1.3 Characteristics.** Where provided, boundary lights shall be fixed lights showing white at all angles up to at least 30 degrees above the horizontal. The intensity of the lights shall be not less than 10 candles.

#### 4.2.2 Range lights.

*Note.—Range lights may be provided at land aerodromes without runways that are equipped with boundary*

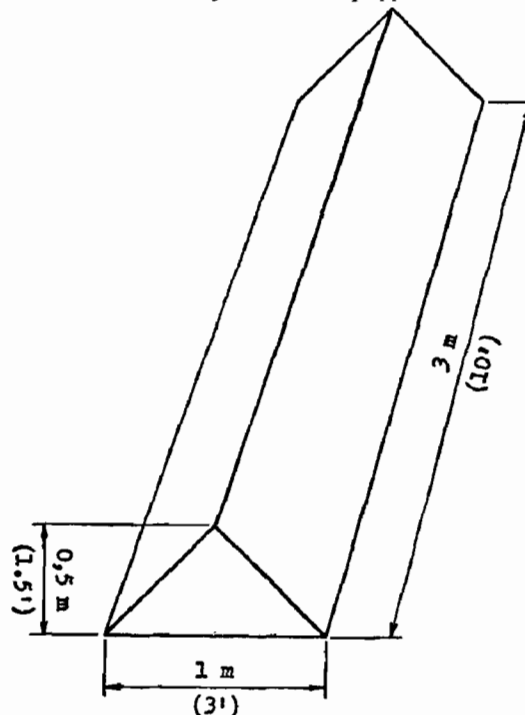

Dimensions are approximative  
Les dimensions sont approximatives  
Las dimensiones son aproximadas

Figure 16. — Boundary Markers

lights, when it is desired to indicate a preferred landing path.

**4.2.2.1 Location.** Where used, range lights shall be arranged in groups at both ends of each preferred landing path. These groups of lights shall form part of the boundary lighting system and shall be arranged to show simultaneously with the boundary lights. The groups used to indicate any landing path shall contain a number of lights different from those used to indicate any other landing path. The lights in a group shall be arranged at equal intervals in a straight line at right angles to the landing path. The landing path prescribed for use under conditions of light winds (less than

5 knots), or in the absence of such prescription, the longest landing path, shall be indicated by light groups containing the greatest number of range lights.

**4.2.2.2 Characteristics.**

**4.2.2.2.1** Where used, range lights shall be fixed lights showing green at all angles up to at least 30 degrees above the horizontal.

**4.2.2.2.2** RECOMMENDATION. — The intensity of the green light should be not less than one-half of the intensity of the white boundary lights and the light distribution should be similar.

## PART VII. — AERODROME EQUIPMENT

### CHAPTER 1. — EMERGENCY POWER SUPPLY

#### 1.1.—APPLICATION

RECOMMENDATION. — An emergency electric power supply should be provided, capable of supplying the power requirements of at least the aerodrome facilities listed below for land aerodromes and at least those facilities listed in *a*), *b*) and *c*) for water aerodromes:

*a*) radio and land-line communication equipment for aeronautical mobile and fixed services as required for the operation of air traffic services, the signalling lamp and the minimum lighting necessary to enable air traffic services personnel to carry out their duties;

*Note.—The requirement for minimum lighting may be met by other than electrical means.*

*b*) radio navigational aids;

*c*) all obstruction lights which, in the opinion of the Competent Authority, are essential to ensure the safe operation of aircraft;

*d*) runway or boundary lights and their associated threshold or range lights.

#### 1.2.—CHARACTERISTICS

1.2.1 RECOMMENDATION. — Electric power supply connections, to those electrically-operated facilities for which an emergency source of power is required, should be so arranged that the facilities are automatically connected, on failure of the normal source of power, to an independent emergency source of supply.

1.2.2 RECOMMENDATION. — The time interval between failure of the normal source of supply and the complete restoration of the services required by 1.1 should be as short as practicable and should not exceed two minutes.

*Note.—In certain cases, less than thirty seconds has been found to be attainable.*

**THIS PAGE INTENTIONALLY LEFT BLANK**

## **ATTACHMENT A**

### **ILLUSTRATIONS AND EXPLANATORY DIAGRAMS**

This attachment does not constitute a part of Annex 14. The material contained herein is intended to assist in the application of the Annex.



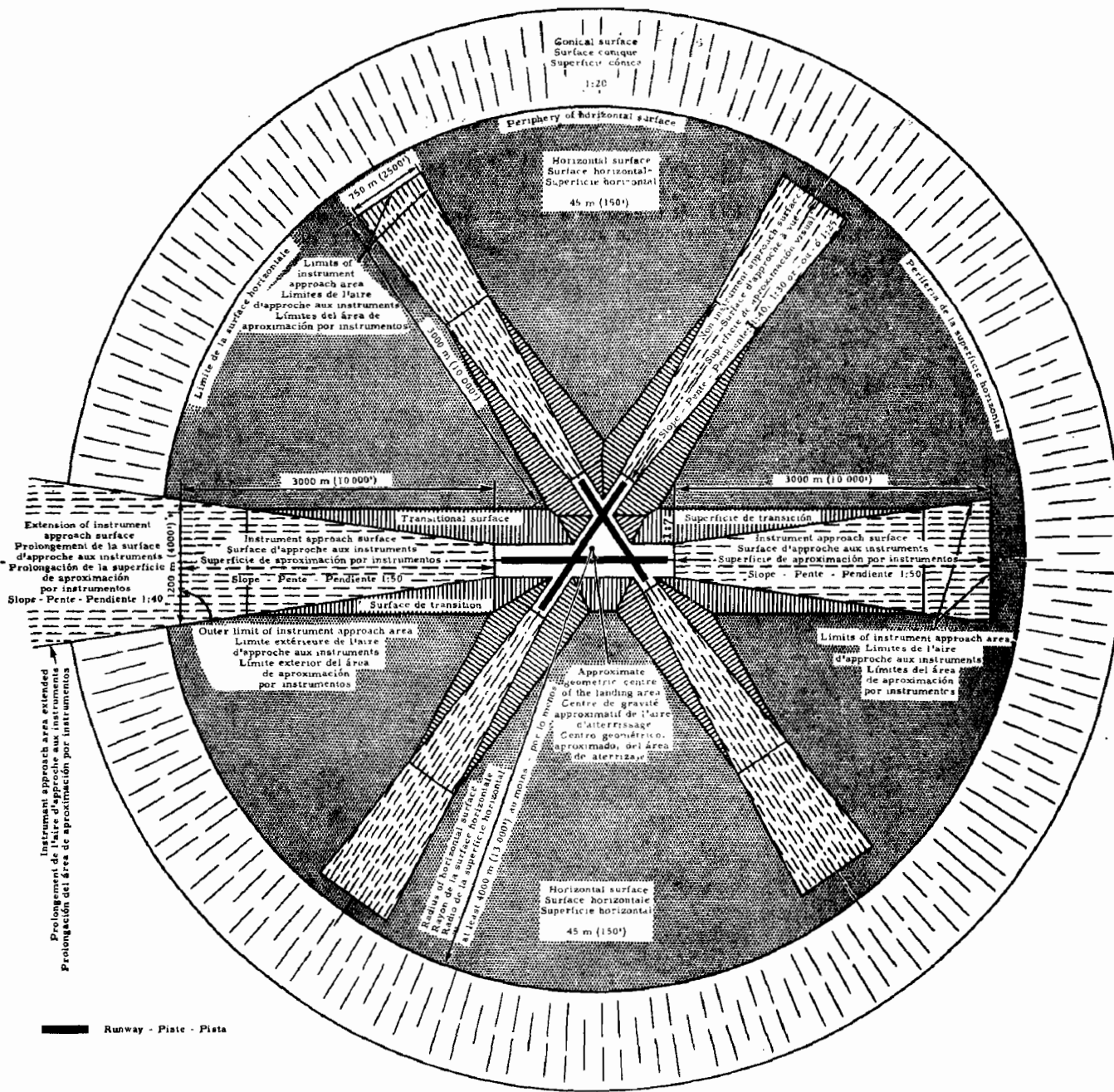

Fig. 17. - Plan View of Clearing and Marking Surface - Typical Land Aerodrome  
 (See Part V, Chapter 1, Section 1 and 2.1.1.1, Note 2)  
 Vue en plan des surfaces de dégagement et de balisage d'obstacles - Aérodrome terrestre type  
 (Cf. 5ème partie; chapitre 1, section 1 et 2.1.1.1, note 2)  
 Vista en planta de las superficies de despeje y señalamiento - Aeródromo terrestre típico  
 (Véase Parte V, Capítulo 1, sección 1 y 2.1.1.1, Nota 2)

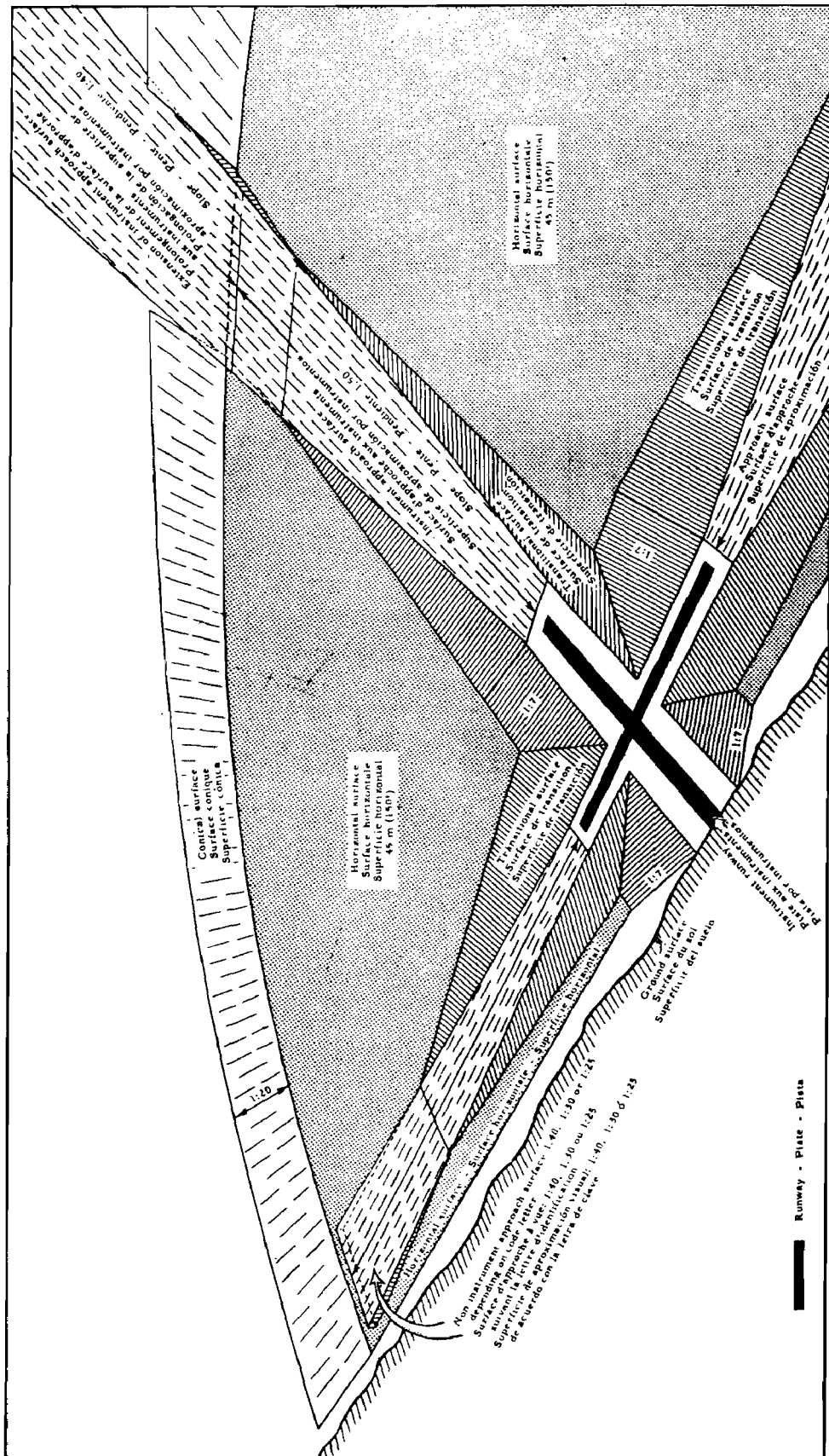

Fig. 18. - View of Clearing and Marking Surfaces - Typical Land Aerodrome  
 (See Part V, Chapter 1, Section 1 and 2.1.1.1, Note 2)  
 Vue des surfaces de dégagement et de balisage d'obstacles - Aérodrôme terrestre type  
 (Cf. 5ème partie: chapitre 1, section 1 et 2.1.1.1, note 2)  
 Vista de las superficies de despeje y señalamiento - Aeródromo terrestre típico  
 (Véase Parte V, Capítulo 1, sección 1 y 2.1.1.1, Nota 2)

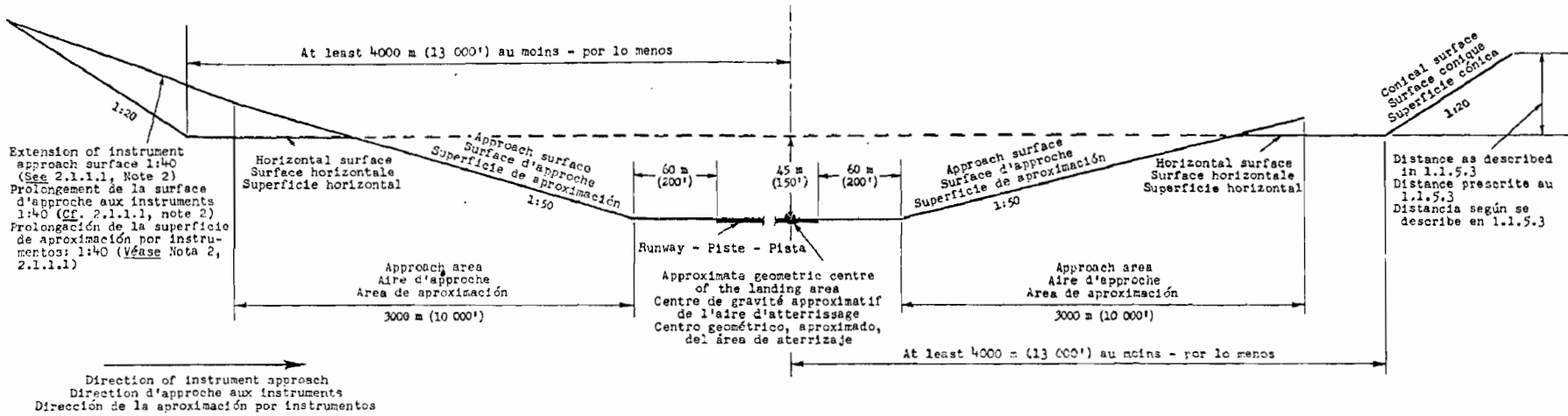

Fig. 19. - Typical Vertical Section of Clearing and Marking Surfaces along Centre Line of Instrument Runway (See Part V, Chapter 1, Section 1 and 2.1.1.1, Note 2)  
Coupe verticale type des surfaces de dégagement et de balisage d'obstacles suivant l'axe de la piste aux instruments (Cf. 5ème partie: chapitre 1, section 1 et 2.1.1.1, note 2)  
Sección vertical típica, de las superficies de despeje y señalamiento a lo largo del eje de la pista de vuelos por instrumentos (Véase Parte V, Capítulo 1, sección 1 y 2.1.1.1, Nota 2)

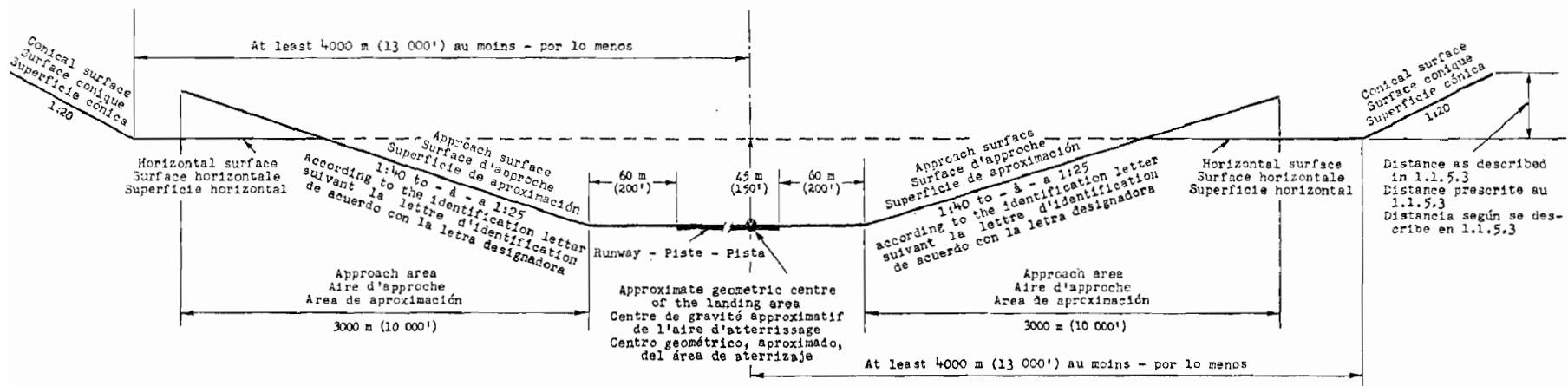

Fig. 20. - Typical Vertical Section of Clearing and Marking Surfaces along Centre Line of Other Required Runways (See Part V, Chapter 1, Section 1)  
Coupe verticale type des surfaces de dégagement et de balisage d'obstacles suivant l'axe d'une piste ordinaire (Cf. 5ème partie: chapitre 1, section 1)  
Sección vertical típica, de las superficies de despeje y señalamiento, a lo largo del eje de las demás pistas necesarias (Véase Parte V, Capítulo 1, sección 1)

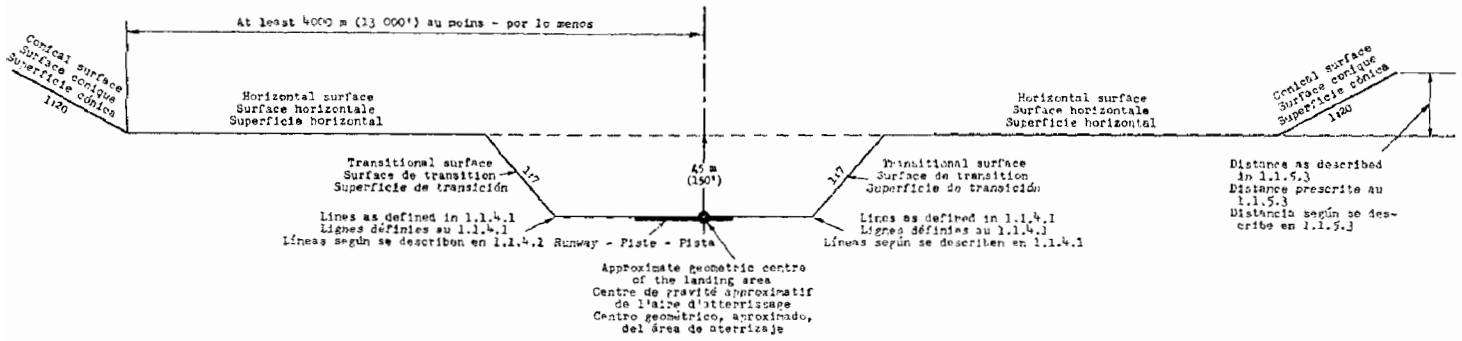
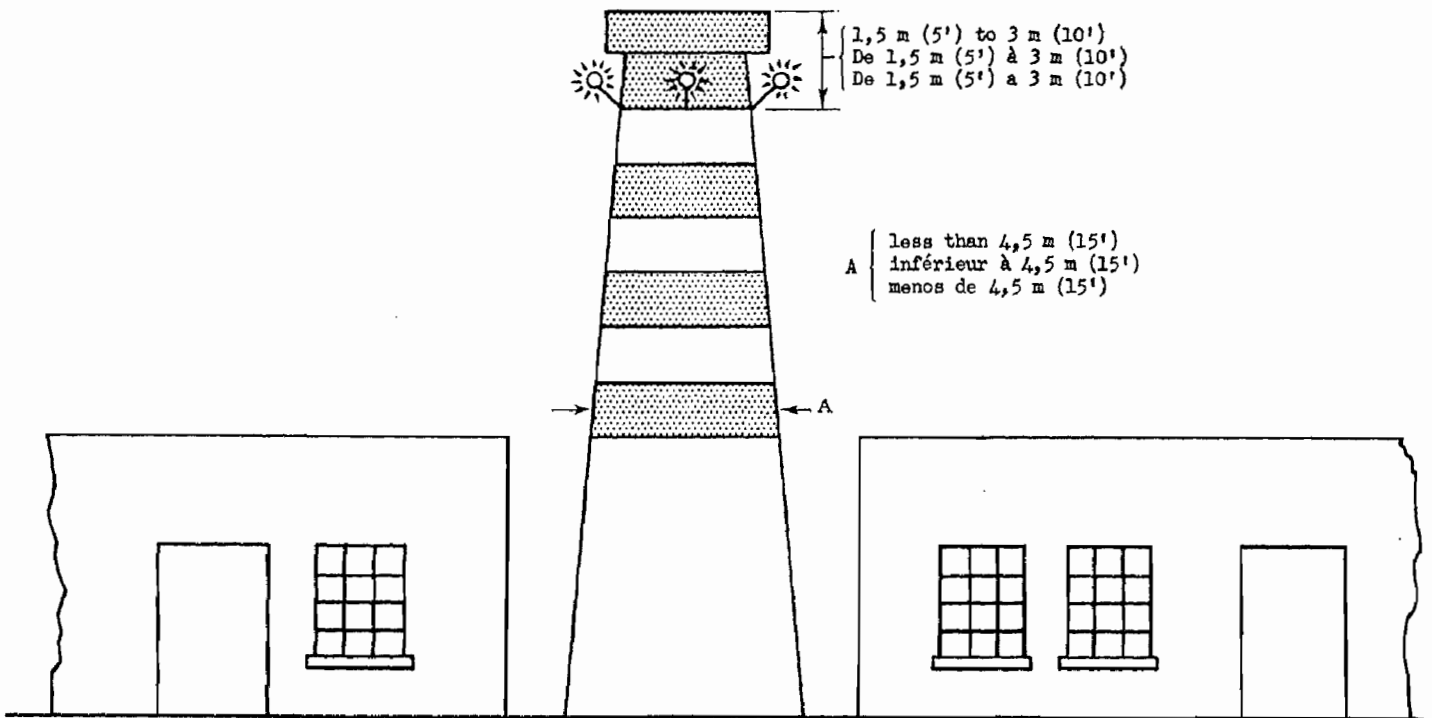
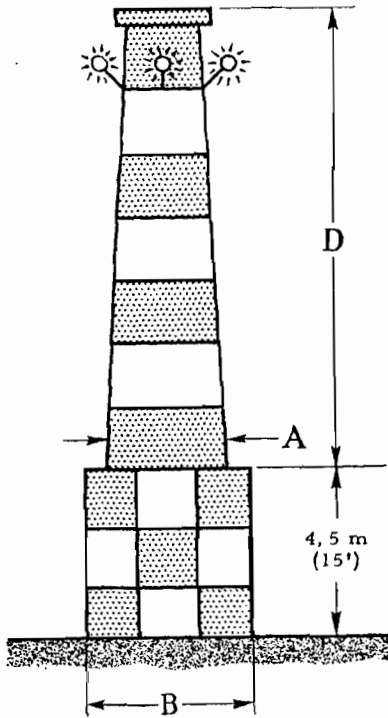

Fig. 21 - Typical Vertical Section of Clearing and Marking Surfaces across Runway  
 (See Part V; Chapter 1, Section 1)  
Coupe type des surfaces de dégagement et de balisage d'obstacles par un plan vertical perpendiculaire à l'axe de la piste  
 (Cf. 5ème partie; chapitre 1, section 1)  
Sección vertical típica, de las superficies de despeje y señalamiento, a través de la pista  
 (Véase Parte V, Capítulo 1, sección 1)



See Use of colours, 3.2.2;  
 Lighting, 3.3.3.2.1.  
 Cf. Balisage à l'aide de couleurs, 3.2.2;  
 Balisage lumineux, 3.3.3.2.1.  
 Véase Empleo de colores, 3.2.2;  
 Iluminación, 3.3.3.2.1.

Fig. 22 - Day and Night Marking Obstruction (See Part V, Chapter 3)  
Balisage de jour et de nuit des obstacles (Cf. 5ème partie, chapitre 3)  
Señalamiento diurno y nocturno de obstáculos (Véase Parte V, Capítulo 3)



- A { less than 4,5 m (15')  
inférieur à 4,5 m (15')  
menos de 4,5 m (15')
- B { 4,5 m (15') or more  
4,5 m (15') ou plus  
4,5 m (15') o más
- D { less than 40,5 m (135')  
inférieur à 40,5 m (135')  
menos de 40,5 m (135')

See Use of colours, 3.2.1.1, 3.2.2.1 and 3.2.2.2;  
Lighting 3.3.3.1 and 3.3.3.2.  
Cf. Balisage à l'aide de couleurs, 3.2.1.1, 3.2.2.1 et 3.2.2.2;  
Balisage lumineux, 3.3.3.1 et 3.3.3.2  
Véase Empleo de colores, 3.2.1.1, 3.2.2.1 y 3.2.2.2;  
Iluminación, 3.3.3.1 y 3.3.3.2.

Fig. 23 - Day and Night Marking  
(See Part V, Chapter 3)  
Balisage de jour et de nuit  
(Cf. 5ème partie, chapitre 3)  
Señalamiento diurno y nocturno  
(Véase Parte V, Capítulo 3)

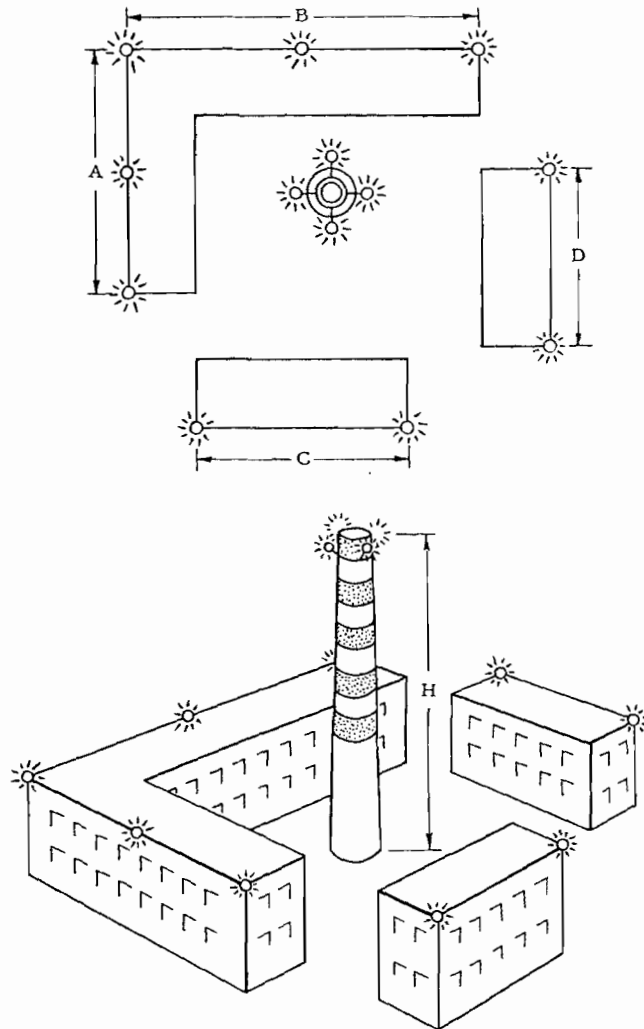

- A, B, H { between 45 m (150') and 90 m (300')  
compris entre 45 m (150') et 90 m (300')  
entre 45 m (150') y 90 m (300')
- C, D { less than 45 m (150')  
inférieur à 45 m (150')  
menos de 45 m (150')

Fig. 24 - Day and Night Marking  
(See Part V, Chapter 3)  
Balisage de jour et de nuit  
(Cf. 5ème partie, chapitre 3)  
Señalamiento diurno y nocturno  
(Véase Parte V, Capítulo 3)

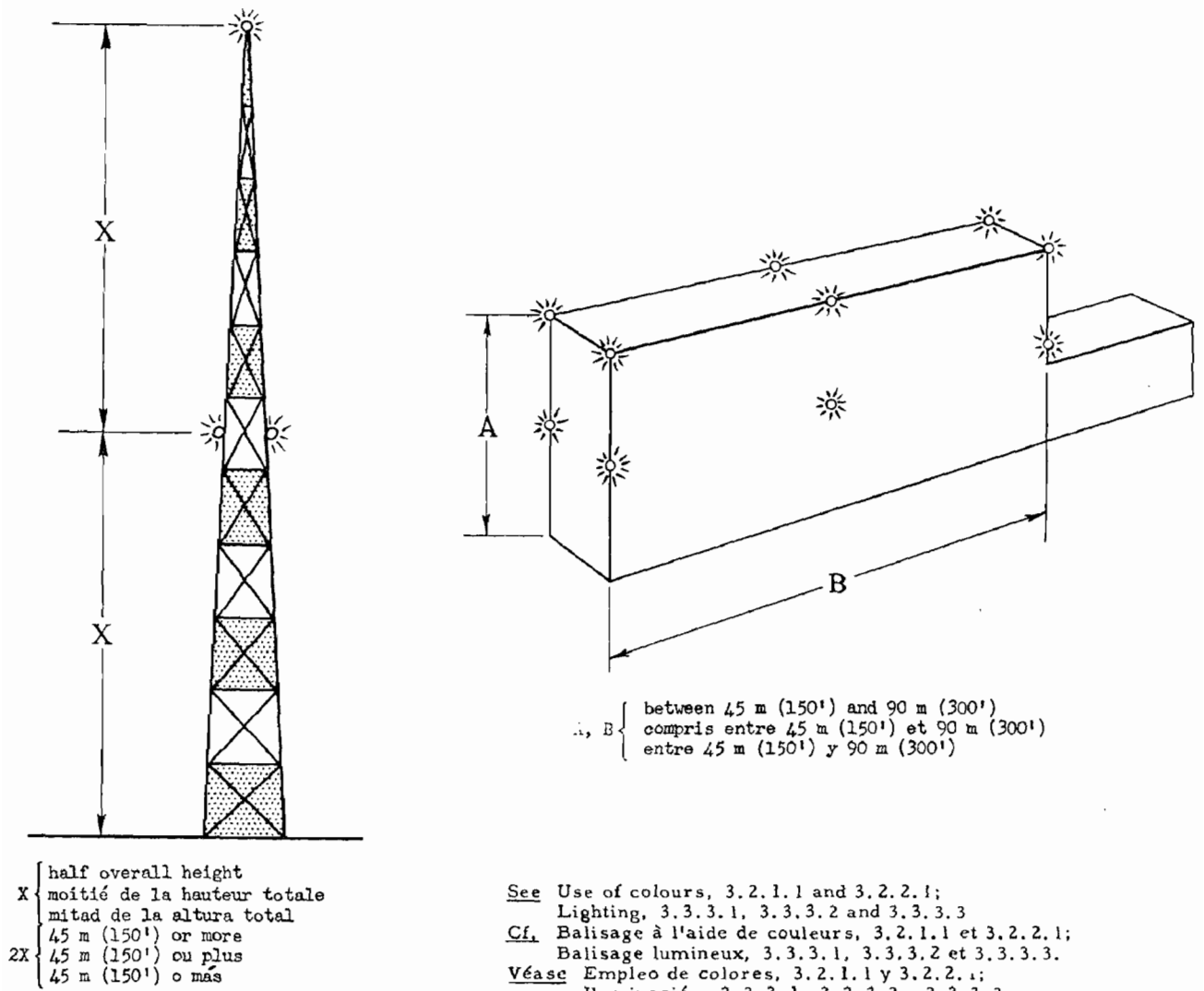
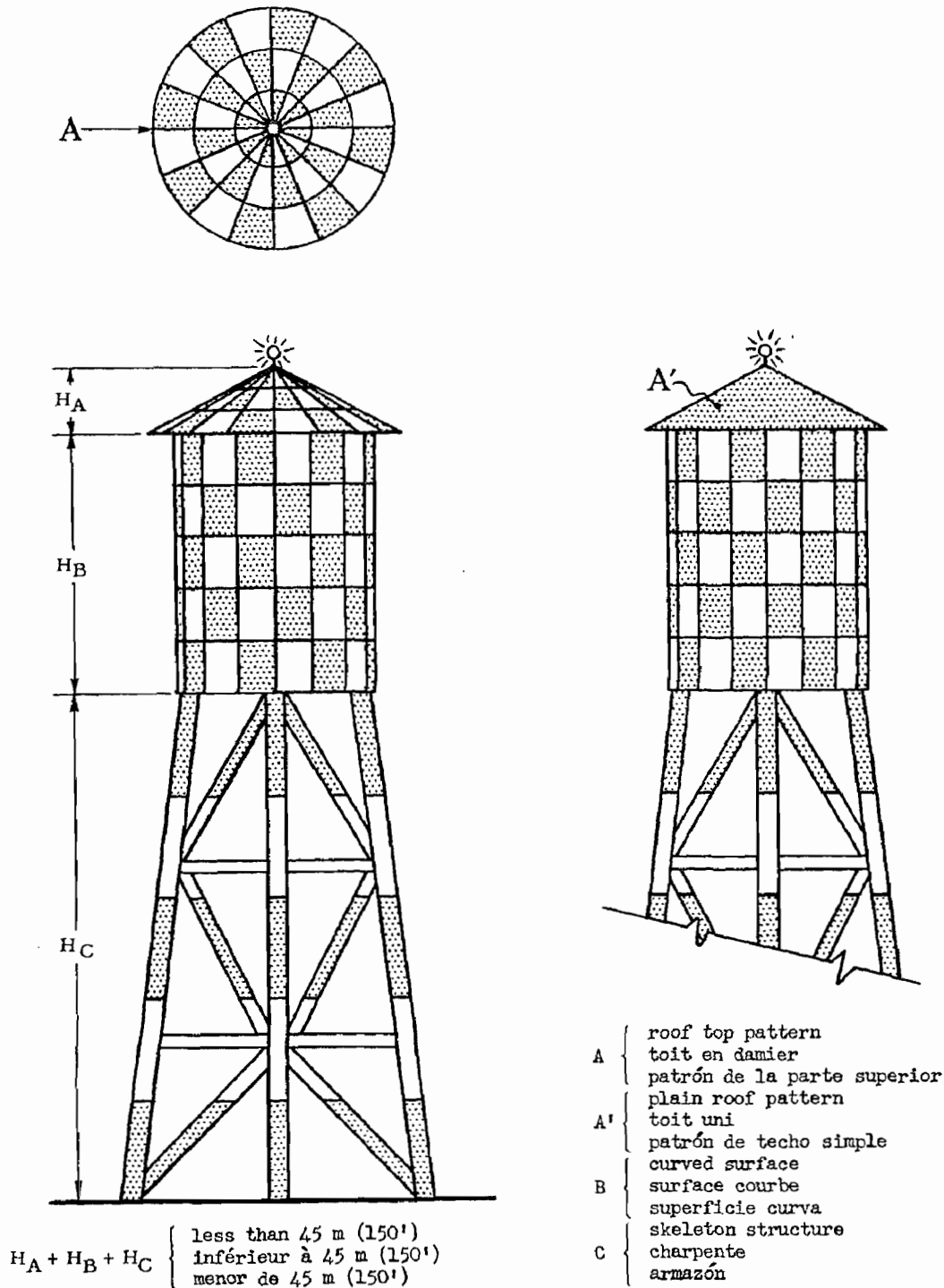

Fig. 25 - Day and Night Marking (See Part V, Chapter 3)  
 Balisage de jour et de nuit (Cf. 5ème partie, chapitre 3)  
 Señalamiento diurno y nocturno (Véase Parte V, Capítulo 3)



See Use of colours, 3.2.2.;  
 Lighting, 3.3.3.2.1.  
 Cf. Balisage à l'aide de couleurs, 3.2.2.;  
 Balisage lumineux 3.3.3.2.1.  
 Véase Empleo de colores, 3.2.2.;  
 Iluminación, 3.3.3.2.1.

Fig. 26 - Day and Night Marking (See Part V, Chapter 3)  
 Balisage de jour et de nuit (Cf. 5ème partie, chapitre 3)  
 Señalamiento diurno y nocturno (Véase Parte V, Capítulo 3)

- H<sub>1</sub> { height 4,5 m (15') or less  
hauteur égale ou inférieure à 4,5 m (15')  
altura 4,5 m (15') o menos
- H<sub>2</sub> { height greater than 4,5 m (15')  
hauteur supérieure à 4,5 m (15')  
altura superior a 4,5 m (15')
- L { 4,5 m (15') or more  
4,5 m (15') ou plus  
4,5 m (15') o más
- W { less than 4,5 m (15')  
inférieur à 4,5 m (15')  
menos de 4,5 m (15')

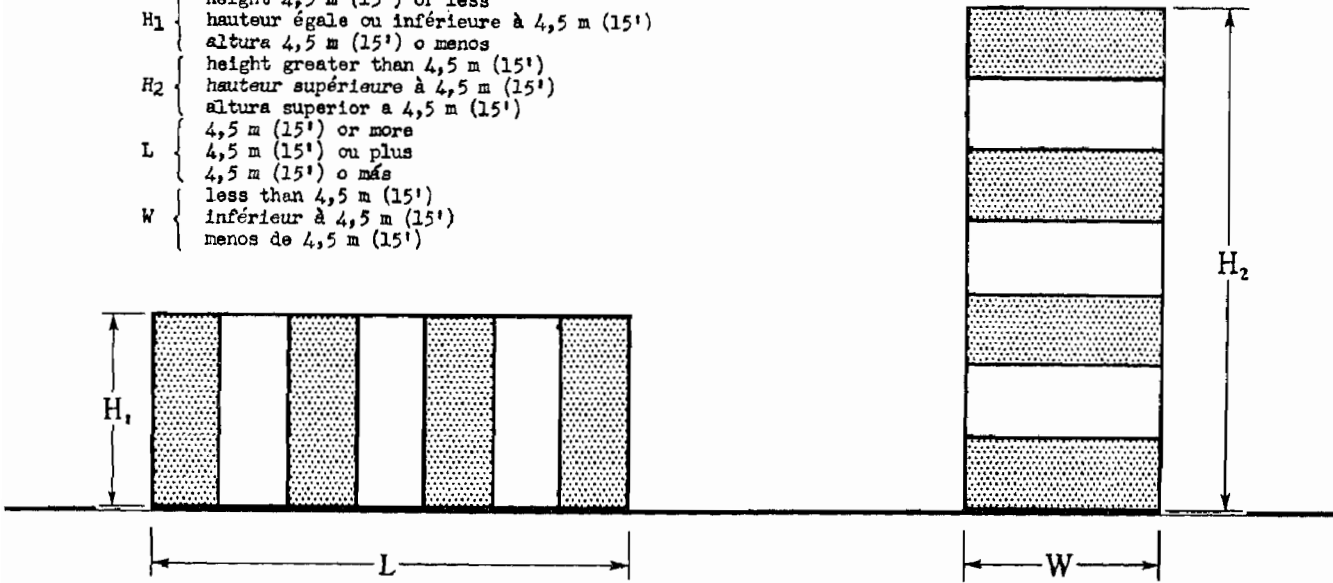

See Use of colours, 3.2.2.1 and 3.2.2.2.  
Cf. Balisage à l'aide de couleurs, 3.2.2.1 et 3.2.2.2.  
Véase Empleo de colores, 3.2.2.1 y 3.2.2.2.

Fig. 27 - Day Marking of Obstructions (See Part V, Chapter 3)  
Balisage de jour des obstacles (Cf. 5ème partie, chapitre 3)  
Señalamiento diurno de obstáculos (Véase Parte V, Capítulo 3)

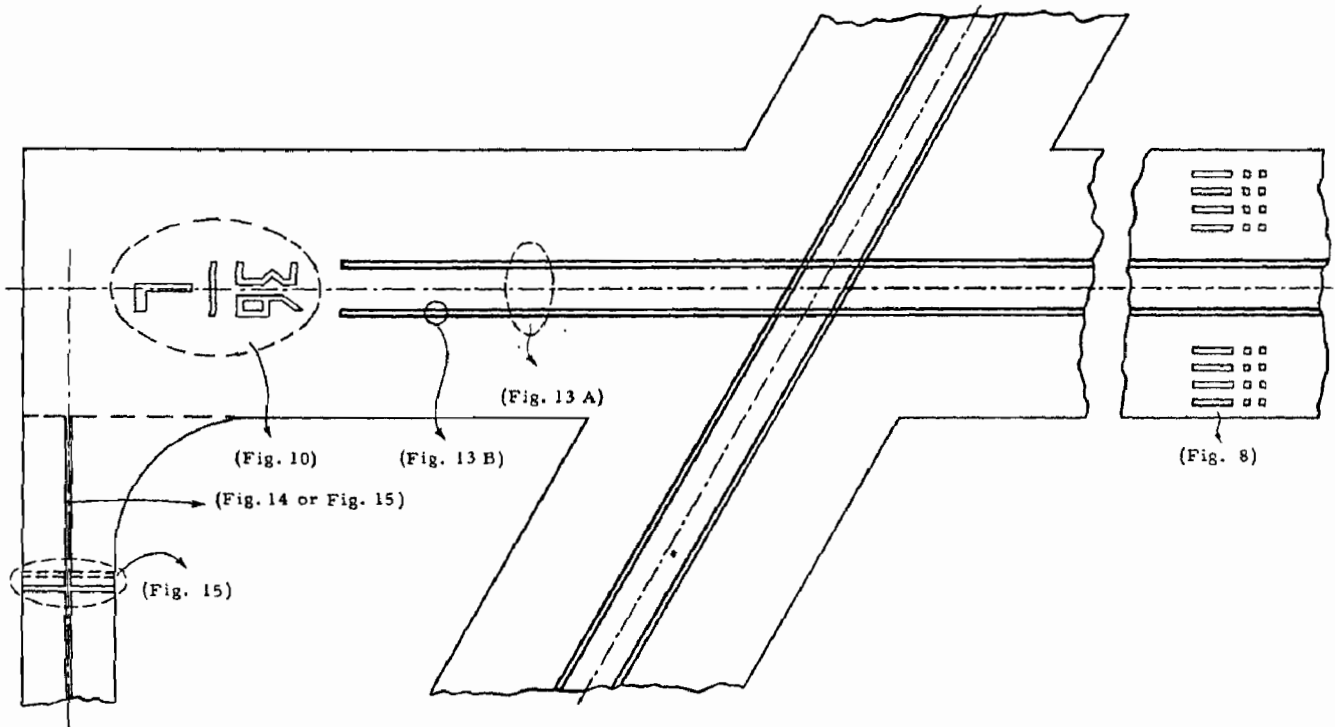

Fig. 28 - Runway and Taxiway Marking  
(See Part VI, 2.1.2 and 2.1.3)  
Balisage de jour des pistes et des voies de circulation  
(Cf. 6ème partie, 2.1.2 et 2.1.3)  
Señales indicadoras de pistas y calles de rodaje  
(Véase Parte VI, 2.1.2 y 2.1.3)



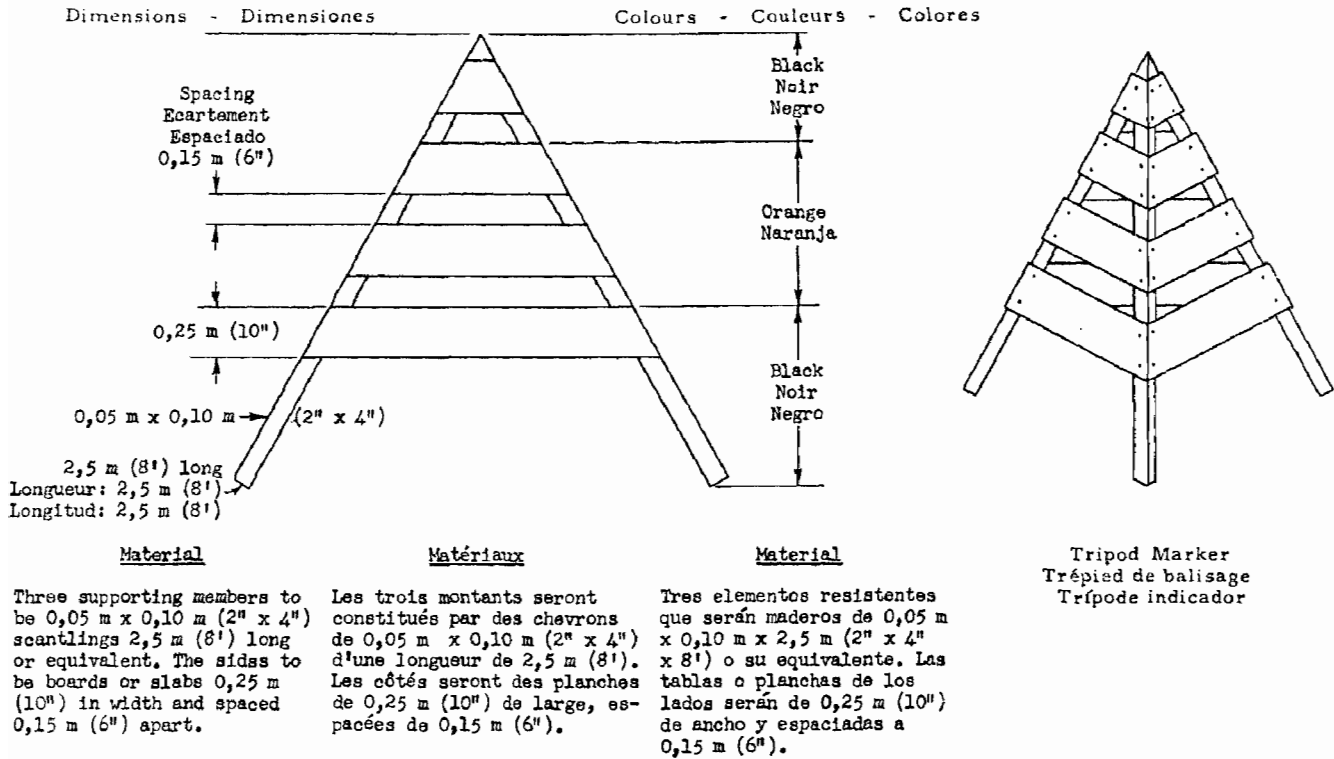

Fig. 29 - Tripod Marker for Snow-Covered Runways (See Part VI, 2.1.2.3.3)  
Trépied de balisage des pistes enneigées (Cf. 6ème partie, 2.1.2.3.3)  
Trípode indicador para pistas cubiertas de nieve (Véase Parte VI, 2.1.2.3.3)

## ATTACHMENT B

### INFORMATION AND MATERIAL FOR GUIDANCE IN THE APPLICATION OF THE STANDARDS AND RECOMMENDED PRACTICES IN ANNEX 14

#### 1.—INTRODUCTION

The material contained in this Attachment is intended to assist in the application of Annex 14. The Attachment does not constitute a part of the Annex and the material is subject to amendment or extension without prior circulation to Contracting States.

#### 2.—AERODROME USABILITY

The Recommendations concerning the number and orientation of runways or channels, Part III, 1.1.1 and 2.1.1, do not prescribe any specific value(s) of cross-wind component to be assumed. Present-day values of the maximum acceptable component cover a wide range, from approximately 5 knots for small private sporting aircraft with fixed undercarriages and tail wheel, to 25 knots or more for medium-sized airliners fitted with swivelling-type undercarriage and large transport-type aircraft with tricycle undercarriages. The selection of an appropriate value for a particular site is left to the Competent Authority who will doubtless take into consideration:

*a)* the kind of aircraft the aerodrome is intended to serve and the "critical cross-wind" component for each as published in the relevant Aeroplane Flight Manual (or similar publication) under "Operating Limitation Information";

*b)* the relative importance of regularity in operation so far as one or more particular classes of aircraft are concerned.

The Competent Authority may, for instance, after taking into consideration the fact that aircraft designs are becoming less critical with respect to wind conditions, decide that the aerodrome is intended to serve those classes of aircraft that are capable of being operated under moderately high cross-wind conditions. It might be found that in such case an aerodrome having one or perhaps two runways or channels will provide the required wind coverage and thus meet the requirements of Part III, 1.1.1 and 2.1.1.

The Competent Authority will then apply the specifications interrelating the physical characteristics and marked with an asterisk (*see* Part I, 2.1.1) to the above-mentioned one or two runways.

Should he subsequently decide to use or to provide one or more additional runways or channels to serve smaller types of aircraft that are more sensitive to the effects of high cross-wind components, he may use his discretion in regard to the "interrelated physical characteristics" and perhaps design them on the assumption that the main runway or channel length code letter is one which identifies a lower range of lengths.

#### 3.—STANDARD ATMOSPHERE

Annex 8 (Airworthiness of Aircraft) gives the following definition for standard atmosphere:

An atmosphere in which

*a)* the air is a perfect dry gas;

*b)* the temperature at sea level is 15°C (59°F);

*c)* the pressure at sea level is 760 millimetres (29.92 inches) of mercury (1013.3 millibars);

*d)* the temperature gradient from sea level to the altitude at which the temperature becomes -56.5°C (-69.7°F) is -0.0065°C per metre (-0.003566°F per foot), and zero thereabove.

*Note.*—The density  $\rho_0$  at sea level under the above conditions is 0.12497 kg sec<sup>2</sup>/m<sup>4</sup> (0.002378 lb. sec<sup>2</sup>/ft<sup>4</sup>).

Proposals for the detailed specifications of the ICAO standard atmosphere and extreme atmospheres contain the following suggested modifications to the definition:

The pressure at sea level should read:

760 mm (29.92126 inches) of mercury (1013.25 millibars);

instead of

760 mm (29.92 inches) of mercury (1013.3 millibars).

The value of the density  $\rho_0$  at sea level given in the note to the general definition should be:

0.12492 kg sec<sup>2</sup>/m<sup>4</sup> (0.0023769 lb. sec<sup>2</sup>/ft<sup>4</sup>);

instead of

0.12497 kg sec<sup>2</sup>/m<sup>4</sup> (0.002378 lb. sec<sup>2</sup>/ft<sup>4</sup>).

#### 4.—MAIN RUNWAY OR CHANNEL BASIC AND ACTUAL LENGTH

It will be noted that the principle underlying the Recommendations (Part III, Chapters 1 and 2) concerning the actual lengths of runways or channels is the same both for new and for existing aerodromes. The Competent Authority first selects a main runway or channel basic length to suit the requirements of the traffic that the aerodrome is intended to serve. Then, by adding any additional length necessary to take into account density altitude and slope, if any, he arrives at the minimum actual length needed for the main runway or the main channel. In the case of an existing aerodrome, the Competent Authority has only to compare this required length with the existing length of the main runway or channel in order to determine whether extension is necessary or not. The reverse process of subtracting "corrections" for density altitude and longitudinal slope (if any) from the actual length of the main runway or channel at an existing aerodrome, in order to obtain the basic length, is not prescribed for the following reasons:

a) there is no internationally accepted method of calculating the corrections to be made for specific longitudinal slopes;

b) the actual length of the main runway or channel at an existing aerodrome may be greater or less than that required for the traffic that it is intended to serve both now and in the future. An attempt to use a basic length arrived at by subtracting "corrections" for density altitude and slope from the actual length is likely to lead to the development of either an uneconomically large aerodrome or an aerodrome that is too small for the traffic it is intended to serve.

Difference	Cent.	0	10	20	30
	Fah.	0	18	36	54
Percentage		0	5%	10%	20%

*United States practice.*—Altitude correction — Basic length to be increased by 7 per cent per 300 metres (1,000 feet) of elevation above sea level.

Temperature correction — Altitude corrected length to be further increased by 0.5 per cent for each degree Fahrenheit which the temperature of the hottest month exceeds the standard temperature of the site.

#### 5.2.—Additional runway length to be allowed for longitudinal slope

Because of the wide variety of possible longitudinal

For this reason it is always preferable to add corrections to a wisely selected main runway or channel basic length than to subtract "corrections" from the actual length of a main runway or channel the origin of which is in no way connected with current or future civil air traffic requirements.

#### 5.—RUNWAY OR CHANNEL LENGTH CORRECTIONS

##### 5.1.—Additional runway or channel length to be allowed for differences from sea level standard atmospheric conditions

As stated in Part III, Chapters 1 and 2, the accepted method of calculating density altitude allowance may not prove adequate in the case of aerodrome sites subject to particularly high temperature and high relative humidity, particularly if the aerodrome is intended to serve turbo-jet engined aircraft.

To take care of such special cases, certain States correct the runway or channel basic length selected for temperature and altitude separately, in the manner indicated in the following extracts from official documents:

*French practice.*—Additional length for altitude: 5 per cent of the basic length per 300 metres (1,000 feet) above sea level.

Further additional length for temperature: variable percentages according to the difference between the mean of the highest daily temperatures in the hottest month of the year and the standard temperature of 15°C (59°F), as shown in the following table:

slopes on runways, it has not yet proved possible to produce an internationally accepted method of determining appropriate allowances.

The following extracts from official documents will afford useful guidance:

1) *French practice.*—The additional length of a runway should be calculated at the rate of 3.5 per cent of the uncorrected length where the code letter is A, B, C, D, E, F or G if the average slope of the runway

reaches 1 per cent. Where the code letter is E, F or G, the additional length should be 6 per cent of the uncorrected length if the average slope reaches 1.5 per cent.

2) *United Kingdom practice.*— For average aircraft under average operating conditions the unstick distance is increased by approximately 10 per cent for every 1° a runway is inclined above the horizontal.

3) *United States practice.*— The runway length should be increased to correct for runway gradient at the rate of 20 per cent of the length corrected for density altitude for each 1 per cent of effective runway gradient. The effective runway gradient is determined by dividing the maximum difference in runway centre line elevation by the total length of the runway.

#### 6.—DISTANCE BETWEEN SLOPE CHANGES

As an example of how the Recommendations contained in Part III, 1.1.6.4, is intended to be applied, consider the case illustrated in the following profile:

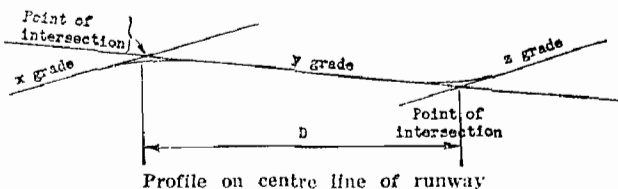

D should be at least

$$7,500 (|x-y| + |y-z|) \text{ metres or}$$

$$25,000 (|x-y| + |y-z|) \text{ feet}$$

$|x-y|$  being the absolute numeral value of  $x-y$   
 $|y-z|$  being the absolute numeral value of  $y-z$

Assuming  $x = + 0.01$

$y = - 0.005$

$z = + 0.005$

Then  $|x-y| = 0.015$

$|y-z| = 0.01$

To comply with the specification, D should be not less than  $7,500 (0.015 + 0.01)$  metres, that is,  $7,500 \times 0.025 = 187.50$  metres

or

$25,000 (0.015 + 0.01)$  feet,

that is,  $25,000 \times 0.025 = 625$  feet.

#### 7.—RUNWAY STRENGTH

The AGA Division at its Third Session recommended the association of tire pressures with single isolated wheel load as follows:

Code Number (1)	Selected single isolated wheel load (2)	Associated tire pressure (3)
1	45,000 kgs. (100,000 lbs.)	8.5 kgs./sq.cm. (120 lbs./sq.in.)
2	35,000 kgs. ( 75,000 lbs.)	7.0 kgs./sq.cm. (100 lbs./sq.in.)
3	27,000 kgs. ( 60,000 lbs.)	7.0 kgs./sq.cm. (100 lbs./sq.in.)
4	20,000 kgs. ( 45,000 lbs.)	7.0 kgs./sq.cm. (100 lbs./sq.in.)
5	13,000 kgs. ( 30,000 lbs.)	6.0 kgs./sq.cm. ( 85 lbs./sq.in.)
6	7,000 kgs. ( 15,000 lbs.)	5.0 kgs./sq.cm. ( 70 lbs./sq.in.)
7	2,000 kgs. ( 5,000 lbs.)	2.5 kgs./sq.cm. ( 35 lbs./sq.in.)

The Division noted, however, that "it is possible that higher tire pressures may be used in future aircraft".

The following table gives values of the equivalent single isolated wheel load of a certain number of modern types of aircraft, together with the tire pressure in each main gear wheel. For the computation of the equivalent single isolated wheel load, the following assumption has been made: in the case of single main wheels, the single isolated wheel load has been taken as being 0.45 of the gross weight; in the case of dual wheels, as being 0.35 of the gross weight; in the case of dual tandem wheels, as being 0.22 of the gross weight; and for 8-wheel bogey main under-carriage, 0.18 of the gross weight.

Aircraft type	Gross weight		Number of wheels on each main under-carriage leg	Equivalent single isolated wheel load		Tire pressure in main gear wheel(s)	
	kgs.	lbs.		kgs.	lbs.	kgs./cm <sup>2</sup>	lbs./sq./in.
Bristol Brabazon 167-Mk 2	148,500	330,000	8	27,000	60,000	7.8	112
SNCASE — SE-2010	75,000	168,000	2	26,600	59,000	9.3	132
Boeing Stratocruiser B-377	66,000	146,000	2	23,000	51,000	7.3 8.4	105 (inboard) 120 (outboard)
Bristol 175	59,000	130,000	4	12,800	28,600	8.7	125
De Havilland Comet	50,000	110,000	4	10,900	24,200	8.4	120
Lockheed 749-A	48,000	107,000	2	16,800	37,500	8.4	120
Douglas DC-6	41,000	91,000	2	14,300	31,800	7.7	110
Hermes 5	38,000	84,000	2	13,200	29,400	5.4	77
Canadair DC-4M	36,000	80,000	2	12,600	28,000	6.3	90
Douglas DC-4	33,000	73,000	2	11,500	25,600	6.3	90
A.V.Roe C-102	30,500	68,000	2	10,700	23,800	5.2	75
Ambassador Airspeed	23,500	52,500	2	8,300	18,400	5.4	77
Vickers Viscount	22,500	50,000	2	7,900	17,500	5.9	85
Martin 404	19,000	42,000	2	6,600	14,700	4.1	58
Convair 240	18,000	40,000	2	6,300	14,000	6.6	95
Martin 202	18,000	40,000	2	6,300	14,000	4.2	60
Super DC-3	14,000	31,000	1	6,300	14,000	4.2	60
Beech Twin Quad	8,800	19,500	1	4,000	8,800	4.2	60

## 8.—TAXIWAY AND APRON STRENGTH

When applying Part III, 1.3.7 and 1.4.3, account is usually taken of the established fact that slow-moving or stationary aircraft impose higher stresses than fast-moving ones, in the following manner: the strength of the taxiways and of those portions of the aprons that accommodate the heaviest aircraft that the aerodrome is intended to serve, is computed on the basis of a single

isolated wheel load equal to 125 per cent of that on which the main runway strength is computed.

## 9.—RUNWAY THRESHOLD MARKING

The following method of marking runway thresholds to increase their conspicuity under conditions of poor visibility (*see* Part VI, 2.1.2.1.3.1) is considered appropriate:

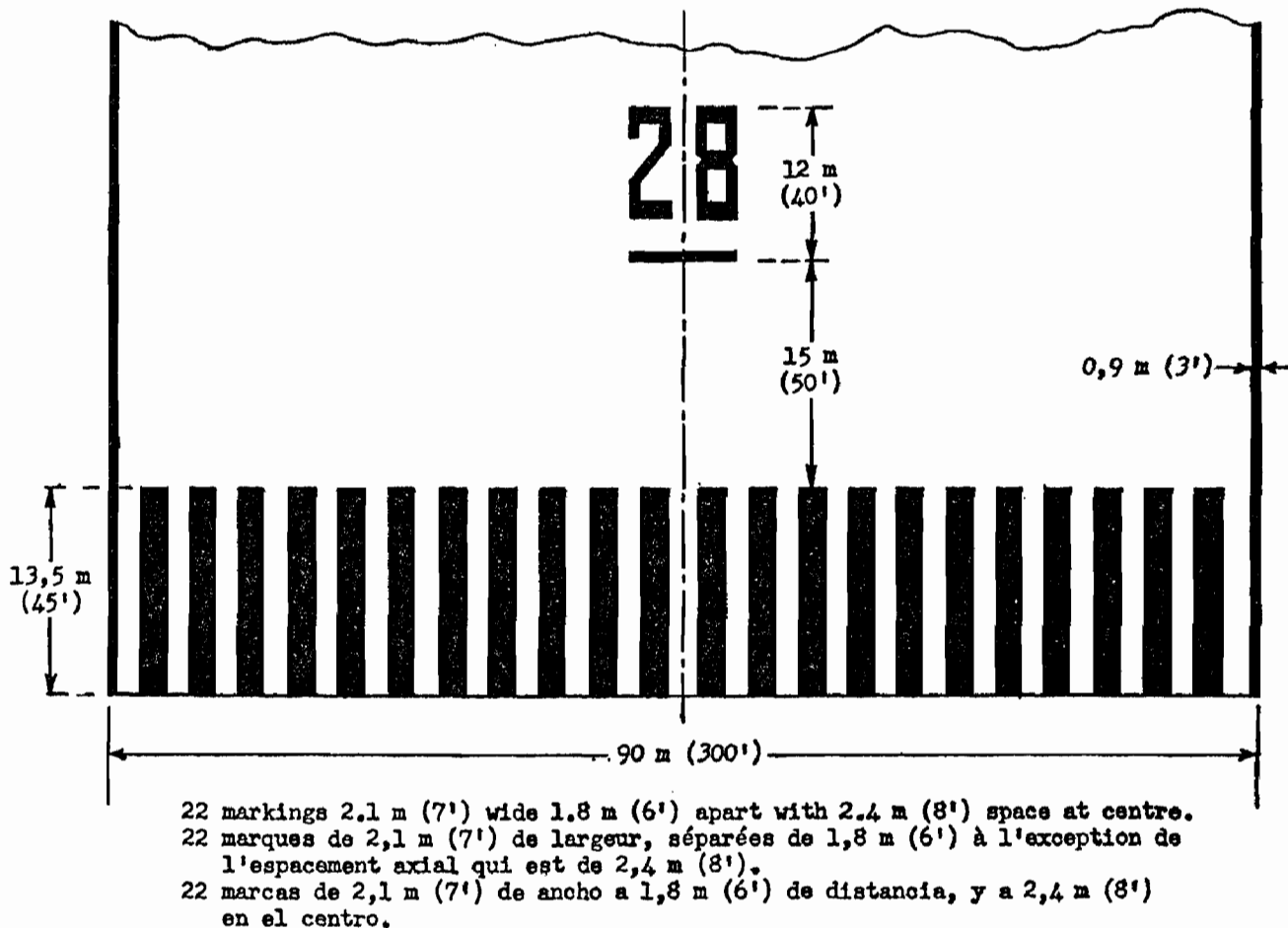

Figure 30

**THIS PAGE INTENTIONALLY LEFT BLANK**

# HISTORICAL NOTE ON THE DEVELOPMENT OF ANNEXES TO THE CONVENTION

At Chicago in November 1944, the International Civil Aviation Conference, at which fifty-two States were represented, drew up an Interim Agreement on International Civil Aviation and a Convention on International Civil Aviation that was to supersede it. The Conference further prepared draft technical annexes to the Convention and resolved that they should be accepted as models of scope and arrangement to be studied by participating States who undertook to submit comments on them by 1 May 1945. The comments were to be considered by technical committees established by the Provisional International Civil Aviation Organization and the annexes, in their final form, accepted for attachment to the Convention. Meanwhile, States of the world were urged to accept the recommended practices contained in the draft technical annexes as those towards which the national practices of the several States should be directed as rapidly and as far as might prove practicable.

The Provisional International Civil Aviation Organization was formed on 6 June 1945 and the Interim Council convened on 15 August 1945. It immediately began to improve the technical annexes by preparing PICAQ's Recommendations for Standards, Practices and Procedures drafted in meetings by technical experts from Member States and international organizations. The meetings were those of subcommittees of the Air Navigation Committee, the nomenclature of which was subsequently changed to Divisions\*.

\*The following ten Divisions were established under PICAQ and have continued under ICAO:

- Accident Investigation (AIG)
- Aerodromes, Air Routes and Ground Aids (AGA)
- Aeronautical Maps and Charts (MAP)
- Airworthiness (including Aircraft Nationality and Registration Marks) (AIR)
- Communications (COM)
- Meteorology (MET)
- Operations (OPS)
- Personnel Licensing (PEL)

The Divisions were aided in improving their recommendations by the comments of technical experts representing Member States of the Organization, non-member States and other international organizations at Regional Air Navigation Meetings and at special meetings. Moreover, the technical experts and administrative authorities of all States were accorded three months in which to scrutinize and comment upon the Recommendations of each Division. Meanwhile, under the Interim Agreement, Member States undertook to apply as rapidly as possible in their national civil aviation practices the PICAQ Recommendations for Standards, Practices and Procedures.

ICAO came into being on 4 April 1947. On 20 June 1947, the ICAO Council recommended that Contracting States should continue to apply in their national civil aviation practices the Recommendations for Standards and Recommended Practices of PICAQ and that they should similarly apply, insofar as they individually considered it advisable and appropriate, the divisional recommendations on which the Council had not yet acted. Many Contracting States made progress in this direction.

The First Session of the ICAO Assembly expressed general satisfaction with the Recommendations for Standards, Practices and Procedures proposed by the Divisions, but decided to rename them henceforth International Standards and Recommended Practices. It resolved (Resolution

Rules of the AIR and Air Traffic Control (RAC)  
Search and Rescue (SAR)

On 28 November 1950 the Council approved the establishment of an Aeronautical Information Services (AIS) Division, as the result of a recommendation of a Special NOTAM Meeting held in April 1949.

*Note 1—A special Radio Technical Division (COT) held one meeting in November 1946. Its functions are now included in those of the COM Division.*

*Note 2—The PEL Division now includes Training in its functions.*



A1-33) that the Council should examine them in the light of the definitions already promulgated and of the comments of Contracting States and should adopt, as soon as practicable, those on which substantial agreement had been reached. Recommendations that failed to meet these requirements should be referred to the Technical Divisions.

The Second Session of the Assembly recognized that there existed some uncertainty on the part of Contracting States as to when International Standards adopted by the Council would come into effect and when Contracting States would be expected to comply with them, or give notice of non-compliance in accordance with Article 38 of the Convention. It was considered that Contracting States should be allowed a reasonable period for implementing the Standards after receiving notification that a majority of the total number of Contracting States had not disapproved them and that they had, therefore, become effective under Article 90 of the Convention. Accordingly, the Council adopted a resolution on 1 July 1947 providing for the establishment of a date following submission of the Standards by the Council to Contracting States (normally not less than ninety days) after which States could no longer notify disapproval under Article 90, a further date by which the Standards and Recommended Practices should be applied by Contracting States and a date prior to which States unable to comply were expected to give notification to that effect.

The recommendations of the Technical Divisions for Standards and Recommended Practices in their respective fields are submitted in the Final Reports of the Divisions to the Air Navigation Commission (which superseded the Air Navigation Committee in February 1949, pursuant to Article 56 of the Convention). The Assembly at its First Session resolved (Resolution A1-32) that recommendations of the Divisions for Standards and Recommended Practices, or amendments thereto, should be submitted to Contracting States for a period of three months before the Council adopted them in order to give States reasonable time for study. The Air Navigation Commission, with the approval of Council, has adopted a procedure to facilitate this study by Contracting States, whereby the Standards and Recommended Practices proposed by a Division

are reviewed by the Commission as soon as practicable after the termination of the Division session. From the recommendations of the Division, the Air Navigation Commission develops a draft Annex, taking into account also matters arising from regional and special meetings, suggestions by the Secretariat and also material emerging from the Commission's deliberations. The object of this procedure is to assess the areas of agreement reached during the Division session and to develop Standards and Recommended Practices that not only meet essential requirements of safety of air navigation but are likely to be acceptable to a majority of the Contracting States. The draft Annex so prepared is then submitted to States for comment, over a period of three months, in accordance with Resolution A1-32 of the First Session of the Assembly. The comments received from Contracting States are collated and those involving modifications in the draft Annex are studied in conjunction with the Division's original recommendations. The Annex is then finalized by the Air Navigation Commission and presented to Council for adoption under Article 37 of the Convention.

When adopting an Annex the Council requests each Contracting State to notify the Organization, in accordance with Article 38, of any differences that will exist, after the Annex comes into force, between its own regulations and practices and those established by the International Standards contained in the Annex. The differences so notified are promulgated by the Organization to all Contracting States.

As aviation develops, the Divisions will improve and add to the International Standards and Recommended Practices which to-day constitute considerable international agreement painstakingly reached through co-ordination between Contracting States by means of technical discussion extending over a considerable period. Improvements can best be made after Contracting States have had practical experience of applying the principles inherent in the Standards and Recommended Practices. The texts of the International Standards and Recommended Practices provide such principles in the form of minimum requirements in the various fields of air navigation for incorporation into the regulations and administrative practices of each Contracting State.

**PRICE: \$0.75 (Canadian) (Montreal)**  
**Equivalents at date of publication:**  
**L. E. 0.250 ..... (Cairo)**  
**Soles 10.75 ..... (Lima)**  
**£ 0/5/2 ..... (London)**  
**Aust. £ 0/6/3 ..... (Melbourne)**  
**Francs 250 ..... (Paris)**